

**4-H 1500**  
**March 2006**  
**\$5.00**

# **The Incredible EGG**

**4-H Classroom  
Curriculum Guide  
For Grade Level 4-5**

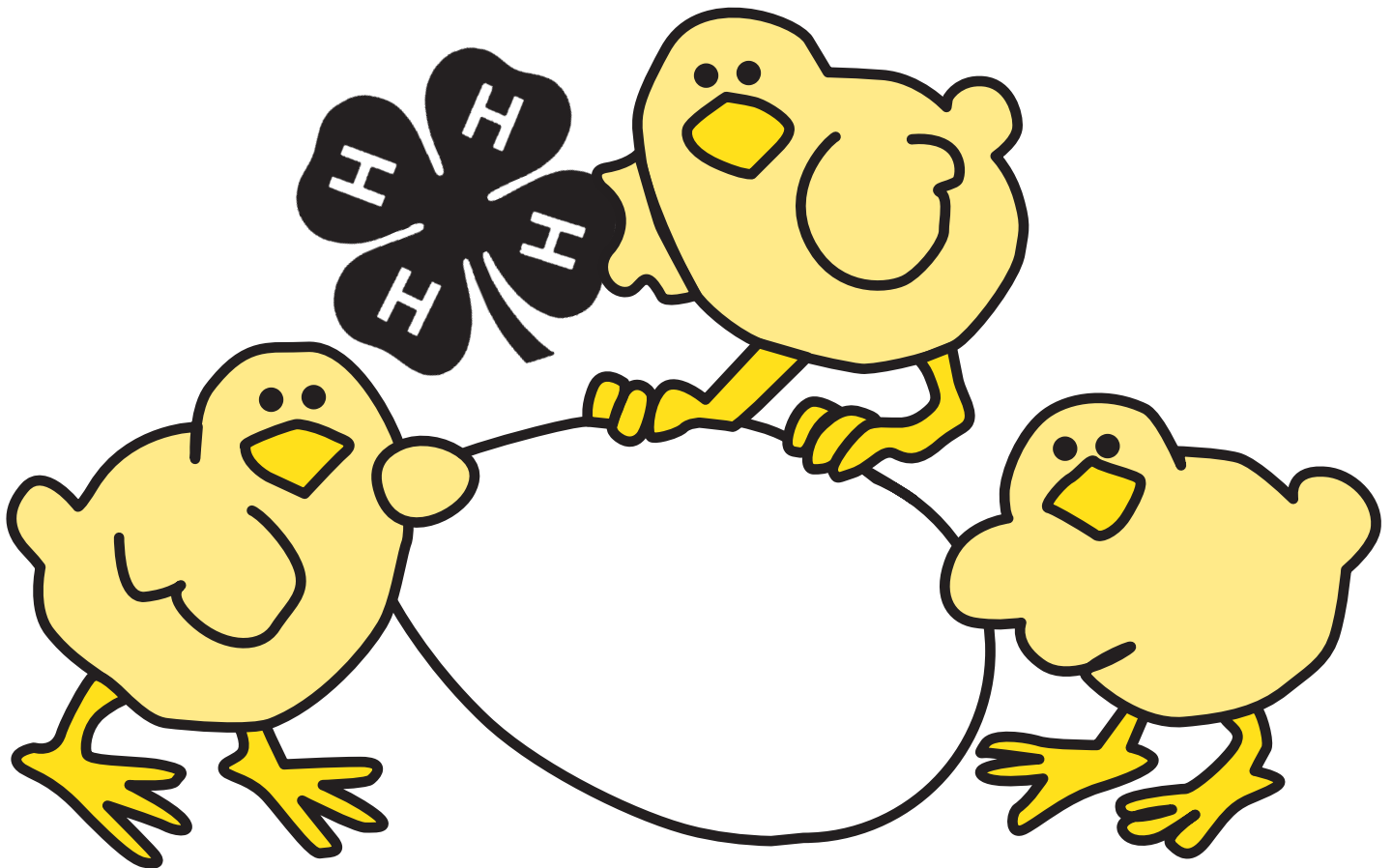

**This curriculum is a product  
of a grant funded by the Meyer Memorial Trust.**

**Oregon State** | Extension  
UNIVERSITY | Service

# Introduction

Oregon State University Extension Service is pleased to share with you a tremendous teaching resource for 4th and 5th grade classes. This unique curriculum, "The Incredible Egg," integrates the concepts of chick embryology into easy-to-use math, science, and language arts lesson plans. In addition, lessons for this curriculum have been linked to "content standards" (as identified in the Oregon Department of Education publication, *Content Standards, Science* [draft], March 1996), in an "at a glance" curriculum matrix. A summary of the significant 4 H life skill outcomes that are targeted for each lesson also is provided.

The lesson plans in this package are designed to be used in sequence or as independent lessons within your classroom curriculum. For example, you may use the lesson plans to address specific math, science, and language arts concepts, or as a combined unit on chick embryology. Teachers using these materials as a chick embryology unit are provided a post-test to measure student achievement, and a certificate of participation for students in this 4 H program.

One of the unique features of this curriculum is that you do not have to incubate eggs to achieve the learning objectives. However, teachers who wish to incubate fertilized eggs to increase student interest in the subject are encouraged to contact the local Extension Service for assistance. They can help you locate fertilized eggs and an incubator. In fact, many county Extension offices offer training programs for conducting a classroom chick embryology program. Specific information on the operation of incubators and the hatching of chicks is contained with the Support Materials in the Appendix of this handbook.

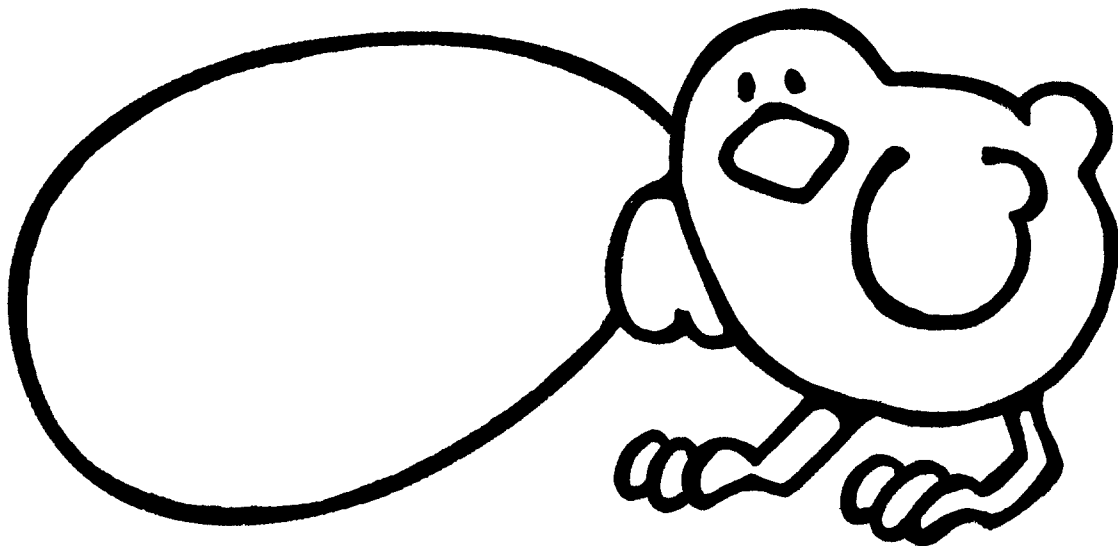

# Table of Contents

<b>Curriculum Matrix</b> .....	<b>4</b>
<b>Lesson 1: The Inside Story</b> .....	<b>6</b>
Science/Language Arts	
<b>Lesson 2: Nutrition</b> .....	<b>19</b>
Science/Health/Math	
<b>Lesson 3: Embryology</b> .....	<b>31</b>
Science/Language Arts/Math	
<b>Lesson 4: Experiments</b> .....	<b>46</b>
Science	
<b>Appendix</b> .....	<b>53</b>
<b>References</b> .....	<b>72</b>

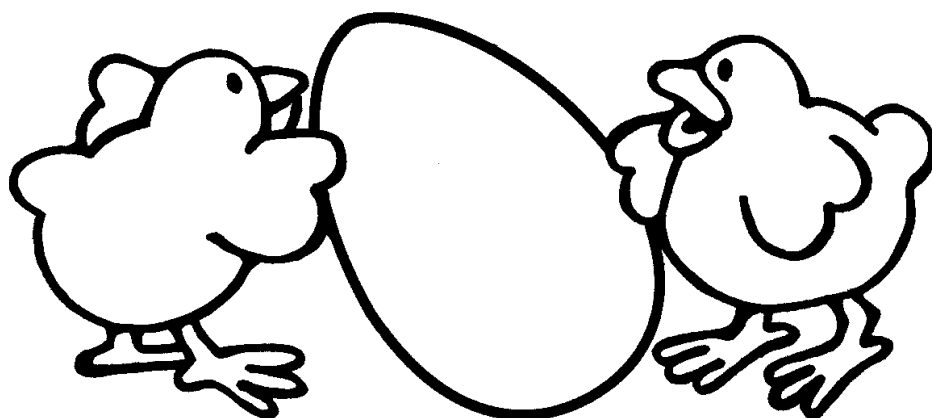

This publication was adapted from the Nebraska Ag in the Classroom Program titled “The Incredible Egg,” originally prepared by Kathy Schellpeper in 1988; and from the 1980 Ohio State University 4 H Classroom Curriculum Guide, also titled *The Incredible Egg*. This publication was revised and prepared for use in the Oregon 4 H animal science program by J. Bradford Jeffreys, Extension specialist, 4 H youth development; and James C. Hermes, Extension poultry specialist, Department of Animal Science. Additional assistance was provided by the following:

Bob Horton, 4 H curriculum specialist, The Ohio State University

Phil Renner, Extension poultry specialist, The Ohio State University

Jeff King, county Extension agent, Ohio 4 H

Bruce Zimmer, county Extension agent, Ohio 4 H

Celeste Thompson, county Extension agent, Ohio 4 H

Jodi Barnhill, graphic artist, Ohio Cooperative Extension Service

Liz Cutler, associate editor, Ohio Cooperative Extension Service

County and district 4 H personnel from the southwest and south Extension districts of Ohio

# Significant 4-H Life Skill Outcomes

Life Skill Areas	Targeted Lessons			
	1	2	3	4
<b>Learning to Learn</b>				
Developing intellectual curiosity	✓			
Learning through experience	✓	✓	✓	✓
Learning by using the five senses				✓
<b>Leading Self and Others</b>				
Working on a team	✓		✓	✓
Identifying one's own competencies			✓	
<b>Relating to Others</b>				
Trusting one's self and others	✓			
Accepting diversity	✓		✓	✓
<b>Communicating with Others</b>				
Disagreeing and refusing	✓			
Speaking before a group		✓	✓	✓
Creative expression			✓	
<b>Planning and Organizing</b>				
Setting short-term goals		✓		

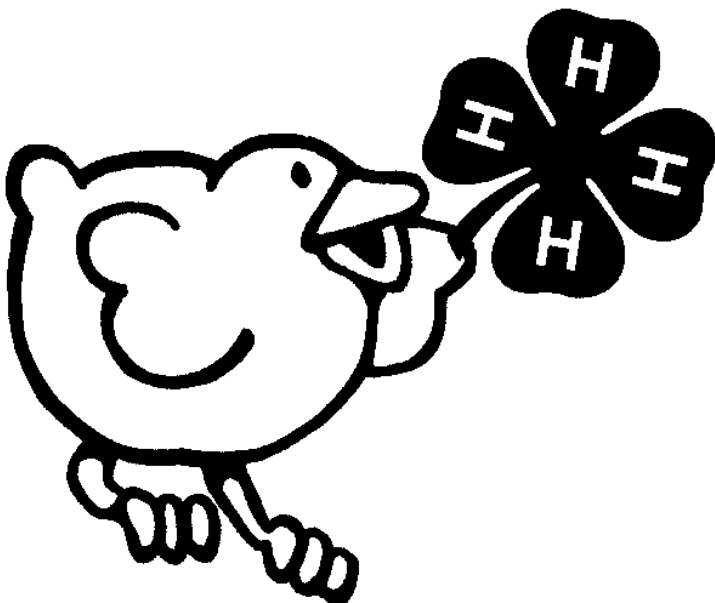

# The Incredible Egg

## 4-H Chick Embryology Program—Biological Science

The 4 H Incredible Egg program is available through your county Extension office. It involves learning more about the egg than just how offspring are produced. Classes have the option of seeing firsthand how baby chicks are hatched. (Incubators are available through the Extension office.)

### Planning Format

Grade Level 4th–5th grade

Goal Cluster or Program Goals	Program Objectives	Subject Area/ Objectives	Activities
The students will develop skills in asking scientific questions and/or making predictions that can be investigated through reading and observation. (5.0*)	<ul style="list-style-type: none"> <li>The students will recognize and be able to describe parts of the egg</li> </ul>	<b>Science/Language Arts</b> <ul style="list-style-type: none"> <li>Identify and name the parts of an egg</li> </ul>	<ul style="list-style-type: none"> <li>Identify the parts of the egg</li> <li>Explain the functions of the parts of the egg</li> </ul>
<b>Lesson Two</b> The students will understand and apply unifying concepts and processes; i.e., how to order a group of objects; to comprehend the role of parts within a system, and identify interactions among those parts; the use of scientific models to explain observations; and the measurement and recording of properties associated with an object or event. (1.0*)	<ul style="list-style-type: none"> <li>The students will recognize in which food group eggs belong</li> <li>The students will understand the nutritional value of an egg</li> </ul>	<b>Science/Health/Math</b> <ul style="list-style-type: none"> <li>Identify the food group in which eggs belong</li> <li>Understand the nutritional value of eggs and realize how many foods use eggs as an ingredient</li> </ul>	<ul style="list-style-type: none"> <li>Identify in which food group the egg belongs</li> <li>Explain the nutritional value of eggs</li> <li>Record all food eaten in a 2-day period</li> <li>Identify which foods eaten contain eggs</li> </ul>

\* *Content Standards, Science* (draft), Division of Curriculum, Instruction and Field Services, Oregon Department of Education, March 1996.

## Goal Cluster or Program Goals

### Lesson Three

The students will understand the structures and functions of living organisms and their interactions with the environment; i.e., describe how adaptation helps an organism survive in its environment. (3.0\*)

- The students will recognize how eggs are hatched
- The students will recognize ideal incubator conditions in hatching eggs

### Lesson Four

The students will develop the skills needed to draw conclusions and make inferences from results of investigations. (5.3\*)

- The students will recognize the scientific method
- The students will draw conclusions on experiments

## Subject Area/ Objectives

### Science/Language/Arts/Math

- Identify the two ways in which eggs are hatched
- Describe the incubator conditions necessary for a healthy chick to hatch
- Explain why these conditions are necessary

- Describe conditions necessary for proper incubation
- Observe the developing embryo
- Take egg weights during incubation

### Science

- Use the scientific method of observing and recording during an experiment
- Draw conclusions after the experiment

- Record the difference between a raw and hard-cooked egg
- Observe and describe the physical aspects of the egg



\* Content Standards, Science (draft), Division of Curriculum, Instruction and Field Services, Oregon Department of Education, March 1996.

# Lesson One

## The Inside Story

### Subject Area

Science/ Language Arts

### Objective

Identify and name the parts and functions of an egg

### 4-H Life Skills

Learning to Learn, Leading Self and Others, Relating to Others,  
Communicating with Others

### Suggested Grade Level

4–5

## Background

### Vocabulary

1. **Shell**—The outside protective layer of the egg. Most chickens lay eggs with brown shells. But some shells may be white or other colors, depending upon the breed of hen. We think of chickens laying white eggs because that is what we see in the market. Shell color does not affect the nutritional value, quality, or favor of eggs. There are tiny pores, or holes, in the shell. These holes allow gasses and moisture to get in and out of the egg.
2. **Shell Membranes**—There are two thin membranes inside the shell, the inner and outer shell membranes. These generally adhere, or stick, to the inside of the shell when a raw egg is cracked open. In addition to the shell, these membranes cover and protect the developing embryo until hatching time.
3. **Air Cell**—The air cell is usually found at the large end of an egg, between the inner and outer shell membranes. Look inside the shell of a raw egg; the shell membranes trap air against the shell. As eggs age, the air cell enlarges because moisture is escaping through the pores in the shell and is replaced by air. This is why fresh eggs sink while older eggs float when put in water.
4. **Albumen**—The clear white of an egg that makes up over half of the egg's weight. This semi-solid material is mostly water and protein, and is found in four layers: inner thick, inner thin, outer thick, outer thin. A very fresh egg has lots of thick albumen and will remain firm. Variations in storage temperature and aging can cause the albumen to thin. The albumen provides food and water for the growing embryo.
5. **Chalazae** (kuh LAY zee)—The thick strands of inner thick albumen at each end of the yolk. These strands anchor the yolk in the center of the egg to keep it from touching the shell. They also serve as a rotating axis to keep the germ cell (developing embryo) on the top of the yolk next to the heat of the hen's body. Often the chalazae are more prominent in fresh, high quality eggs.
6. **Yolk**—The yellow of the egg that comprises about one-third of the egg's weight. Yolks can vary in color from light to dark yellow due to the hen's diet; however, all are equally nutritious. The yolk is the first part of the egg that is formed inside the hen. There is a membrane covering the yolk that may break when cracking an egg. The yolk provides food for the growing embryo.

- 7. Germ (Blastodisk)**—The white spot on the yolk where an embryo can begin to develop if the egg has been fertilized and incubated.
- 8. U.S.D.A.**—The United States Department of Agriculture, which determines the standards for grading eggs. The most common grades are AA and A, with B and Inedible less common. Eggs graded AA will have yolks and albumens that stand taller and firmer than those graded A. B graded eggs have many problems with the shell or contents. Inedible grades have large blood spots. However, all grades have the same nutritional value.

## **Facts About Eggs**

Hens that have been mated to a rooster lay mostly fertilized eggs. This is the way chickens reproduce. Inside each fertilized egg is an embryo that will grow to be a chick. The yolk and albumen of the egg provide food for the growing embryo. The albumen, or white of the egg, also provides the embryo with protection against shock, because it's like a watery sac. The blunt end of the egg contains the air cell. Just before the embryo breaks out of its shell, it takes its first breath of air from this air cell.

Hens that have not been mated to a rooster will still lay eggs. Because these eggs have not been fertilized, they will not hatch. Eggs sold in the grocery store are nearly always infertile.

## **Materials**

1. Chicken eggs
2. Worksheets A, B, C, D, E, and F
3. Transparency A
4. Raw egg in a shell
5. Tin or black pie plate

## **Procedure**

1. Crack the raw egg into a pie tin and place the two shell halves beside it.
2. Have students try to identify parts of the egg and shell. At this time do not identify the parts for the students.
3. To introduce the parts of an egg, label and discuss these parts and functions on Transparency A. Have the students complete Worksheet A with you.
4. Have students look at the raw egg and shell again. See if any students can now identify the learned parts. Look for the air cell, yolk, and membranes.
5. Have students identify, locate, and describe each part of the raw egg on Worksheet A.
6. Have students complete Worksheet B together.
7. Check Worksheet B together.
8. Duplicate Worksheets C and D on heavy paper. Cut out, shuffle, and distribute the eggs, one per student. If a student receives an egg shape with a definition, he/she needs to match with the student who has the egg shape with the term.

If a student has a term, he or she needs to find the matching definition. Give the students a certain amount of time to find their partners without talking. Have them use body and eye signals. When students match they are to stand by each other and raise their hands. If more than 16 are playing, duplicate more eggs or play in two shifts.

9. Have students complete Worksheet E.

## **Eggstra Activities**

- Have the students complete Worksheet F.

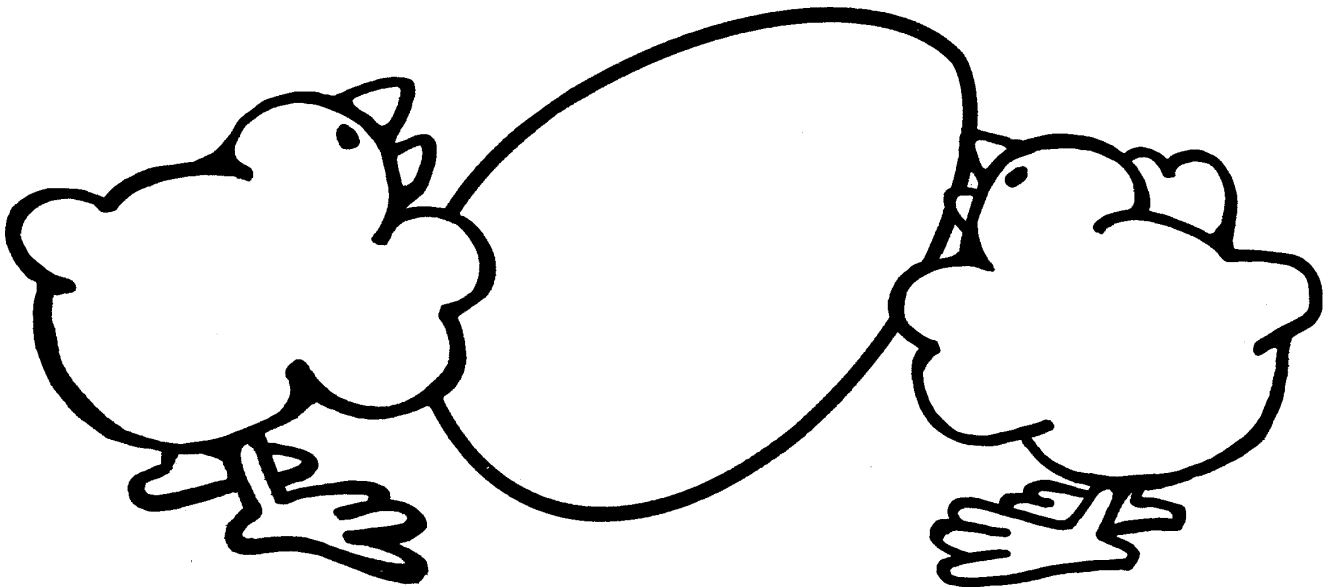

# The Parts of an Egg

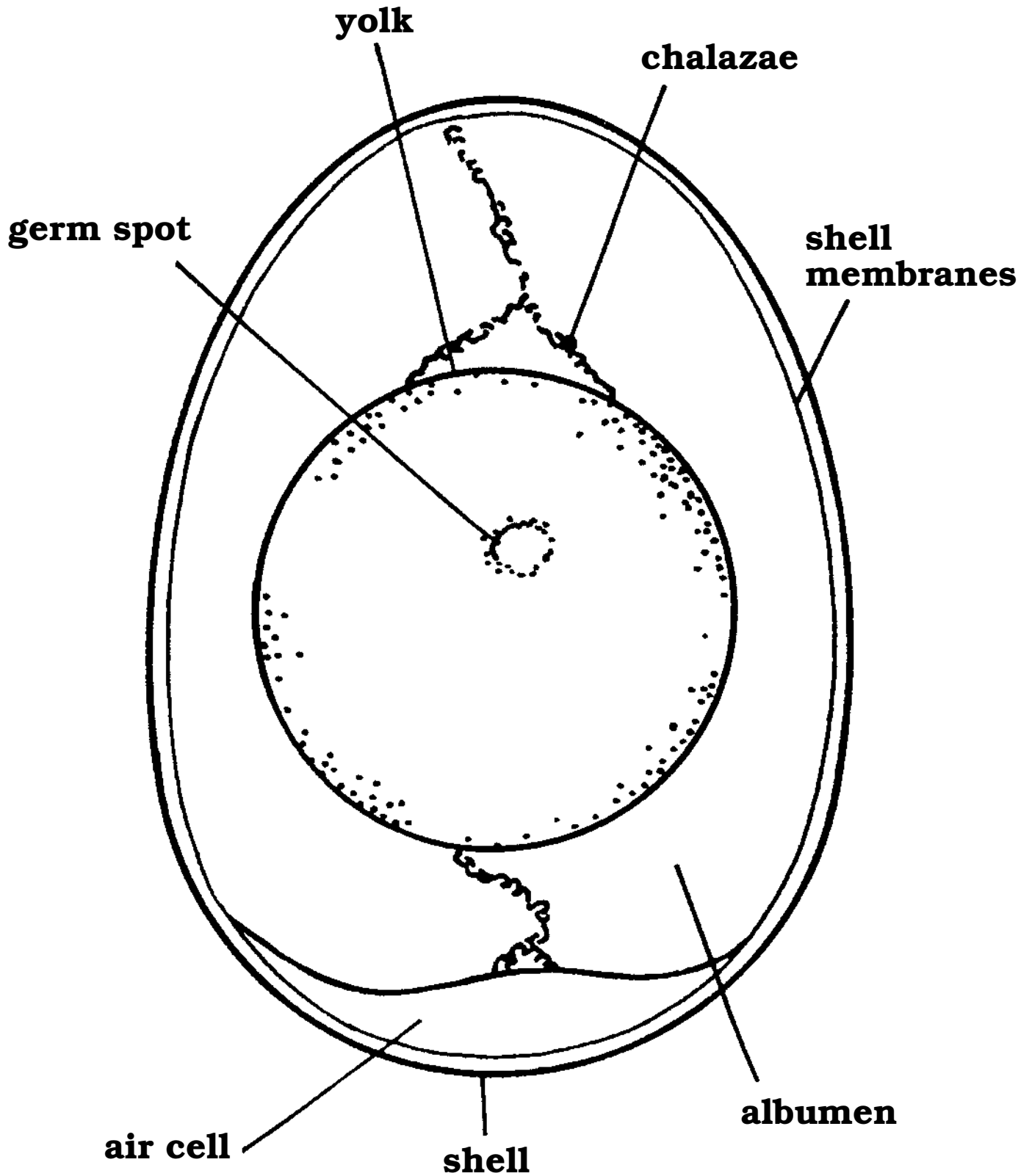

**Transparency A**

Adapted from *Copycat*

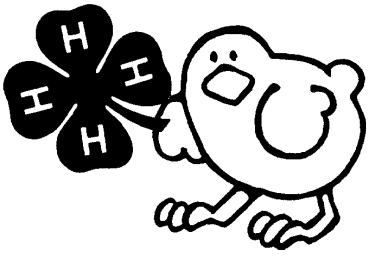

# The Parts of an Egg

Name \_\_\_\_\_

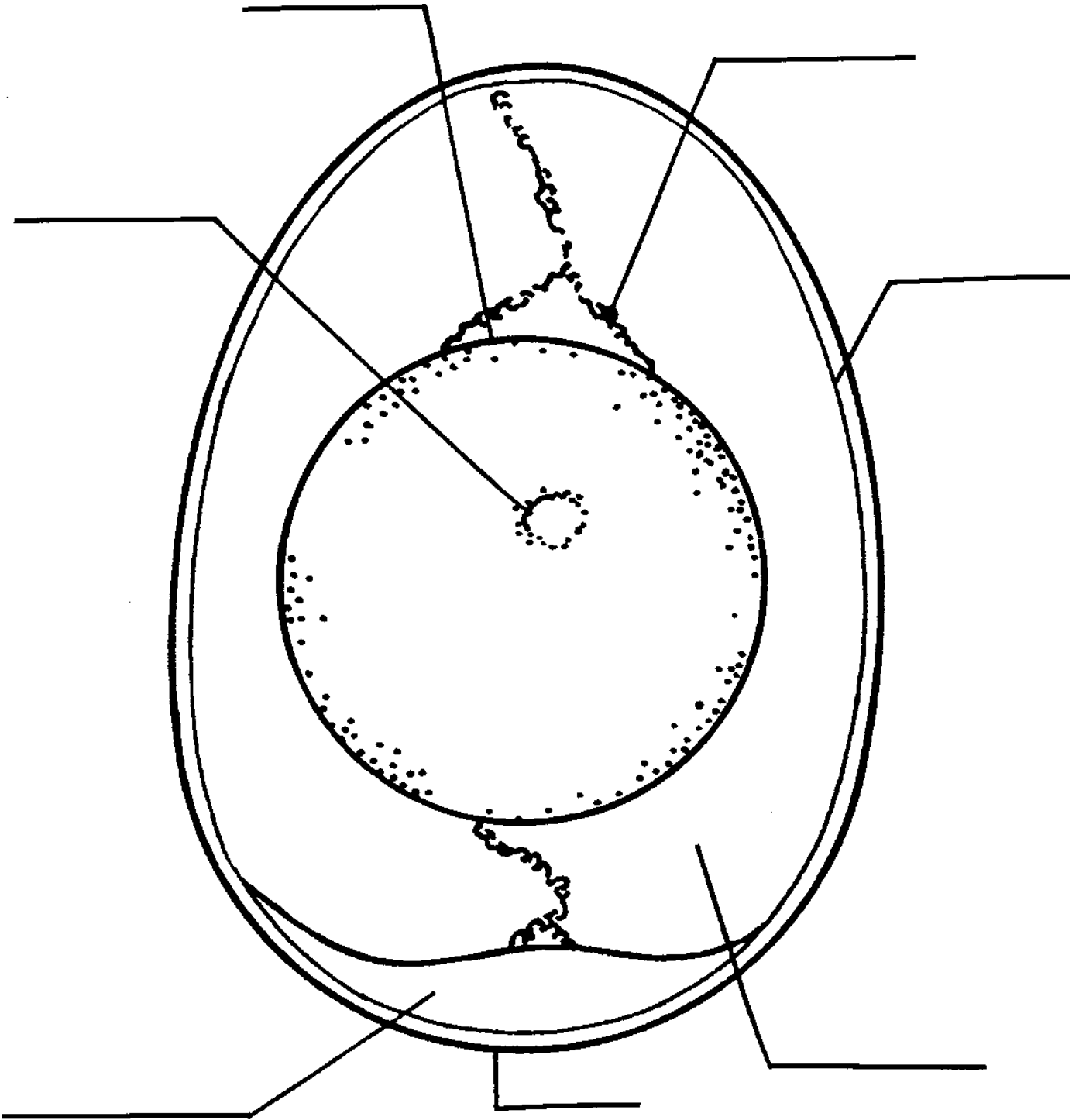

Adapted from *Copycat*

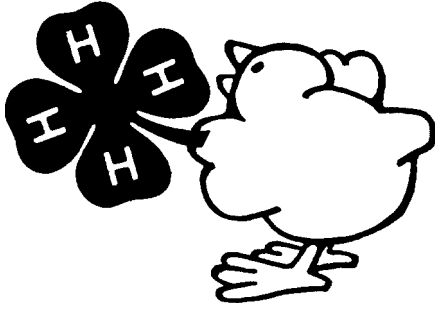

# Embryology Terminology

Name \_\_\_\_\_

Match the terms to the definitions by writing the correct letter in each egg shell.



**Air Cell**



**Albumen**



**Chalazae**



**Shell**



**Yolk**



**Shell Membranes**



**Germ Spot**



**USDA**



**A and AA**

- A.** The white of an egg. This watery substance supplies the growing embryo with food and water.
- B.** The hard protective outer covering of an egg. This has tiny pores in it to allow the passage of gas and moisture in and out of the egg.
- C.** The abbreviation for the United States Department of Agriculture.
- D.** The twisted cords at each end of the yolk. These keep the yolk from moving about and sticking to the shell.
- E.** The yellow of the egg. This is the first food source for the growing embryo.
- F.** The pocket of air at the large end of the egg.
- G.** Two common grades for eggs given by the USDA.
- H.** The “white spot” on the yolk where the embryo develops.
- I.** The two thin layers inside of the egg shell.



# Embryology Terminology

Name ANSWER KEY

Match the terms to the definitions by writing the correct letter in each egg shell.

M F

**Air Cell**

M A

**Albumen**

M D

**Chalazae**

M B

**Shell**

M E

**Yolk**

M I

**Shell Membranes**

M H

**Germ Spot**

M C

**USDA**

M G

**A and AA**

**A.** The white of an egg. This watery substance supplies the growing embryo with food and water.

**B.** The hard protective outer covering of an egg. This has tiny pores in it to allow the passage of gas and moisture in and out of the egg.

**C.** The abbreviation for the United States Department of Agriculture.

**D.** The twisted cords at each end of the yolk. These keep the yolk from moving about and sticking to the shell.

**E.** The yellow of the egg. This is the first food source for the growing embryo.

**F.** The pocket of air at the large end of the egg.

**G.** Two common grades for eggs given by the USDA.

**H.** The “white spot” on the yolk where the embryo develops.

**I.** The two thin layers inside of the egg shell.

M B

**Air Cell**

**USDA**

**Albumen**

**Germ Spot**

**Chalazae**

**Shell  
Membranes**

**Shell**

**Yolk**

The pocket of air in the wide part of the egg.

The watery semi-solid white of an egg. It provides the developing embryo with food and water.

The “white spot” on a yolk. If the egg is fertilized and kept warm then the embryo will begin to develop from this spot.

The hard protective covering of the egg. This has many tiny pores that allow air and moisture to pass in and out of the egg.

The twisted strands (cords) of albumen at each end of the yolk. These anchor the yolk in the center of the shell.

The thin layers inside the shell.

The abbreviation for United States Department of Agriculture.

The yellow of an egg. This is the primary source of food for a growing embryo.

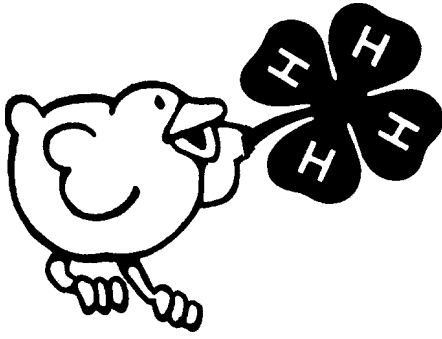

# Embryology

Name \_\_\_\_\_

Eggsactly how much do you remember about eggs?

Use these terms to fill in the parts of this egg.

- Shell Membranes**
- Germ Spot**
- Albumen**
- Chalazae**
- Shell**
- Yolk**
- Air Cell**

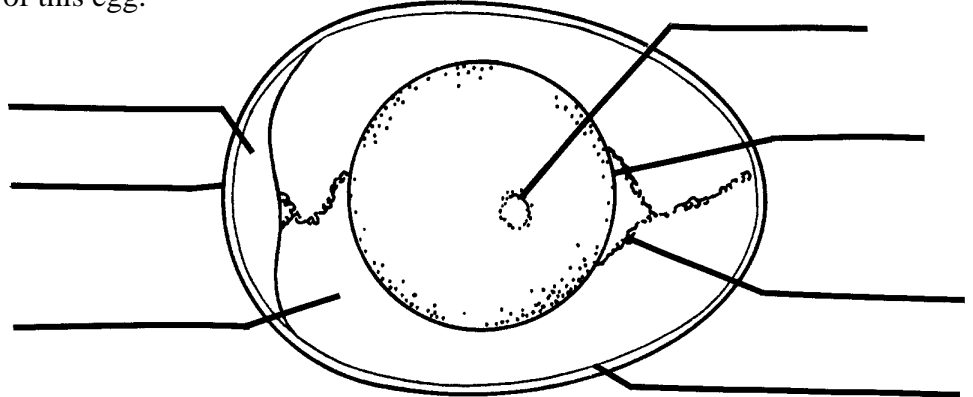

Now fill in the words from this box to make the sentences correct.

<b>Yolk</b>	<b>Germ Spot</b>	<b>Pores</b>	<b>Albumen</b>
<b>Shells</b>	<b>Chalazae</b>	<b>Inedible</b>	<b>AA A B</b>
<b>Air</b>	<b>Membranes</b>	<b>USDA</b>	<b>Moisture</b>

- The yellow of an egg is called the \_\_\_\_\_.
- The \_\_\_\_\_ is usually called the white of an egg.
- The \_\_\_\_\_ on the yolk is where an embryo develops.
- Most chicken breeds lay eggs with brown \_\_\_\_\_.
- At each end of the yolk are \_\_\_\_\_, cords that keep the yolk from sticking to the shell.
- Egg grades are established by the \_\_\_\_\_. Grades used for eggs are \_\_\_\_\_, \_\_\_\_\_, \_\_\_\_\_, and \_\_\_\_\_.
- The egg shell has many tiny \_\_\_\_\_ in it to let air and \_\_\_\_\_ pass through the shell.

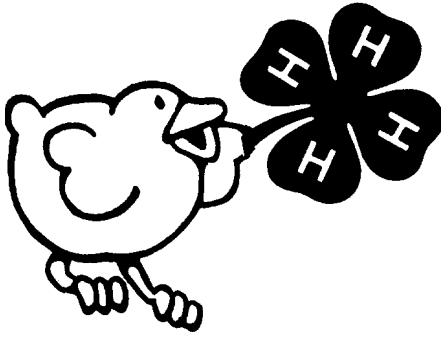

# Embryology

Name ANSWER KEY

Eggsactly how much do you remember about eggs?

Use these terms to fill in the parts of this egg.

**Shell Membranes**  
**Germ Spot**  
**Albumen**  
**Chalazae**  
**Shell**  
**Yolk**  
**Air Cell**

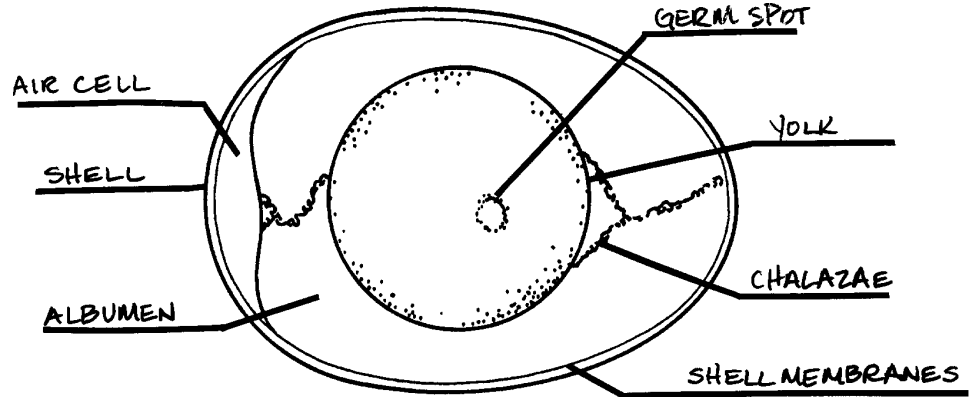

Now fill in the words from this box to make the sentences correct.

<b>Yolk</b>	<b>Germ Spot</b>	<b>Pores</b>	<b>Albumen</b>
<b>Shells</b>	<b>Chalazae</b>	<b>Inedible</b>	<b>AA A B</b>
<b>Air</b>	<b>Membranes</b>	<b>USDA</b>	<b>Moisture</b>

- The yellow of an egg is called the YOLK.
- The ALBUMEN is usually called the white of an egg.
- The GERM SPOT on the yolk is where an embryo develops.
- Most chicken breeds lay eggs with brown SHELLS.
- At each end of the yolk are CHALAZAE, cords that keep the yolk from sticking to the shell.
- Egg grades are established by the USDA. Grades used for eggs are AA, A, B, and INEDIBLE.
- The egg shell has many tiny PORES in it to let air and MOISTURE pass through the shell.

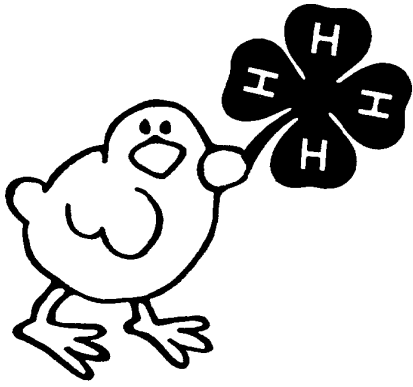

# Alphabetical Order

Name \_\_\_\_\_

Put each group of words in alphabetical order.

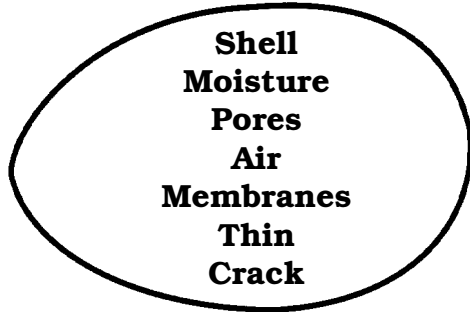

1. \_\_\_\_\_
2. \_\_\_\_\_
3. \_\_\_\_\_
4. \_\_\_\_\_
5. \_\_\_\_\_
6. \_\_\_\_\_
7. \_\_\_\_\_

1. \_\_\_\_\_
2. \_\_\_\_\_
3. \_\_\_\_\_
4. \_\_\_\_\_
5. \_\_\_\_\_
6. \_\_\_\_\_
7. \_\_\_\_\_

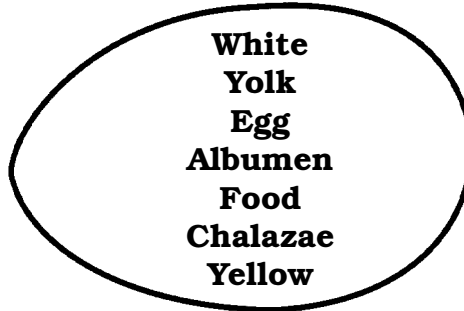

1. \_\_\_\_\_
2. \_\_\_\_\_
3. \_\_\_\_\_
4. \_\_\_\_\_
5. \_\_\_\_\_
6. \_\_\_\_\_

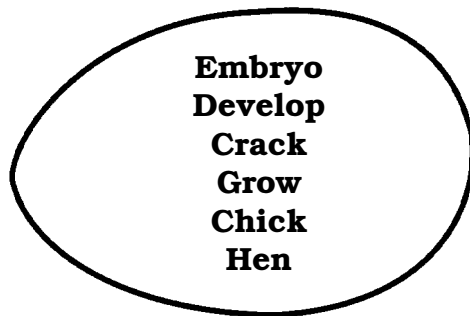

Draw a crack in the egg shell if the words are in alphabetical order.



**Challenge**  
**Chalk**  
**Chalazae**

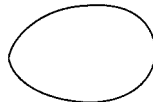

**She**  
**Shelf**  
**Shell**



**Albumen**  
**Along**  
**Already**



**Memory**  
**Membranes**  
**Member**

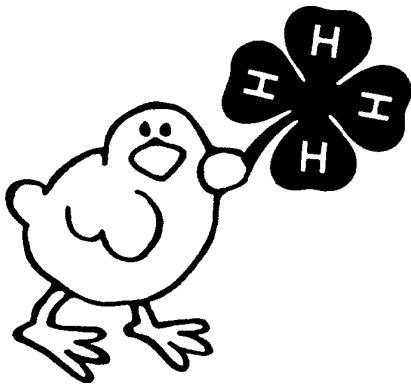

# Alphabetical Order

Name ANSWER KEY

Put each group of words in alphabetical order.

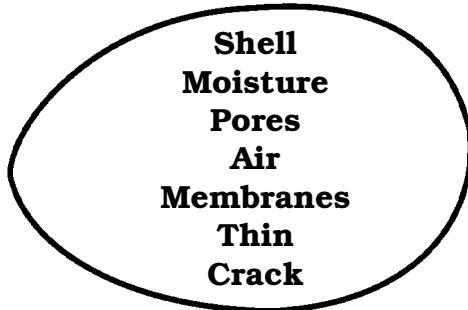

1.     AIR \_\_\_\_\_
2.     CRACK \_\_\_\_\_
3.     MEMBRANES \_\_\_\_\_
4.     MOISTURE \_\_\_\_\_
5.     PORES \_\_\_\_\_
6.     SHELL \_\_\_\_\_
7.     THIN \_\_\_\_\_

1.     ALBUMEN \_\_\_\_\_
2.     CHALAZAE \_\_\_\_\_
3.     EGG \_\_\_\_\_
4.     FOOD \_\_\_\_\_
5.     WHITE \_\_\_\_\_
6.     YELLOW \_\_\_\_\_
7.     YOLK \_\_\_\_\_

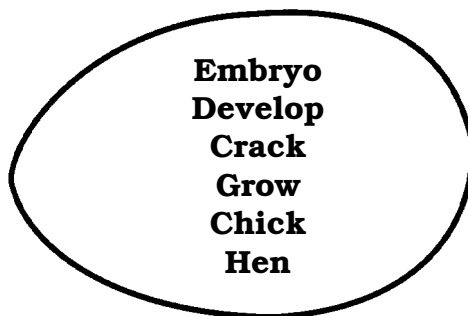
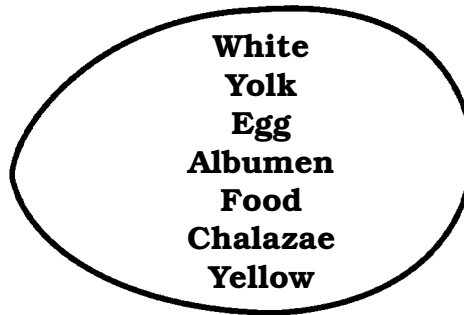

1.     CHICK \_\_\_\_\_
2.     CRACK \_\_\_\_\_
3.     DEVELOP \_\_\_\_\_
4.     EMBRYO \_\_\_\_\_
5.     GROW \_\_\_\_\_
6.     HEN \_\_\_\_\_

Draw a crack in the egg shell if the words are in alphabetical order.



Challenge  
Chalk  
Chalazae



She  
Shelf  
Shell



Albumen  
Along  
Already



Memory  
Membranes  
Member

# Lesson Two

## Nutrition

### Subject Area

Science/Health/Math

### Objectives

- Identify the food group in which eggs belong
- Understand the nutritional value of eggs, and realize how many foods use eggs as an ingredient

### 4-H Life Skills

Learning to Learn, Communicating with Others, Planning and Organizing

### Suggested Grade Level

4–5

## Background

### Eggs are Nutritional!

Eggs are among the most nutritious foods. They are a good source of vitamins A, B, and D; riboflavin, biotin, phosphorus, and some iron also are found in eggs. Eggs are low in calories (with only about 80 in a large one), yet high in protein. In fact, egg protein is extremely high in quality, and includes all the amino acids needed to build and improve body tissues.

### Eggs are Economical!

One dozen large eggs equals 1½ pounds of protein rich food. If large eggs are \$1 per dozen, that is only 67 cents per pound. Of the basic four food groups, eggs are in the meat group and are an “eggcellent” meat substitute, with two eggs equaling one serving of meat.

### Eggs are Incredible!

Eggs can be served any time of the day. In fact, eggs are so versatile, they can be prepared easily in a variety of ways. However, eggs—like other foods—are susceptible to contamination and bacterial growth due to their concentrated content of nutrients and high quality protein. Be certain eggs are cooked completely before eating.

## Materials

1. Daily food intake charts (Worksheet H)
2. Cookbooks
3. Transparencies B1 and B2
4. Worksheet G
5. *A Close Look at MyPyramid for Kids* (H1)

## Procedure

1. Discuss and decide in which food group eggs belong.
2. Discuss the nutritional value of eggs and the role some nutrients play in maintaining a human body, using Transparency B2. You may wish to have students complete Worksheet G as you discuss this topic.
3. Have each student keep track of all the food consumed in a 2 day period using Worksheet H. Students can then compare their food intake choices with those on MyPyramid.gov (B1), or *A Close Look at MyPyramid for Kids* (H1).
4. Later, go over each student's food intake chart to survey the amount of food each student eats that contains eggs. Use the cookbooks for reference. (Students may be surprised with the amount of eggs they have eaten.)

## Eggstra Activities

- Go over *A Close Look at MyPyramid for Kids* on H1. Students may take this home and discuss food groupings with adults and siblings.
- Worksheets I and J (math story problems)
- Prepare eggs before class by soaking them in vinegar for 48 to 72 hours in a refrigerator. The acid in the vinegar will decalcify the shells making them soft and semi-permeable. In class, let your students gently handle the softened eggs so they can observe the differences between an ordinary egg shell and the decalcified shell.
- With your class, conduct the separation experiment entitled "Making Meringue" on page 30.

# **The Food Guide Pyramid**

**A Guide to Daily Food Choices**



# **MyPyramid.gov**

**STEPS TO A HEALTHIER YOU**

# Eggs—A Natural Wonder

## Shell

- Outer covering of egg, composed of calcium carbonate
- Color does not affect quality, cooking characteristics, or nutritional value

## Yolk

- Color varies with feed of the hen, but doesn't indicate nutritional content
- Major source of vitamins, minerals, and fat

## Chalazae

- Prominent chalazae indicate high quality

## Air Cell

- Increases in size with age

## Shell Membranes

- Provide protective barrier against bacteria

## Thin Albumen (White)

- Spreads around thick white of high quality egg

## Thick Albumen (White)

- Excellent source of riboflavin and protein
- Stands higher and spreads less than thin white in high quality eggs
- Thins and becomes indistinguishable from thin white in low-quality eggs

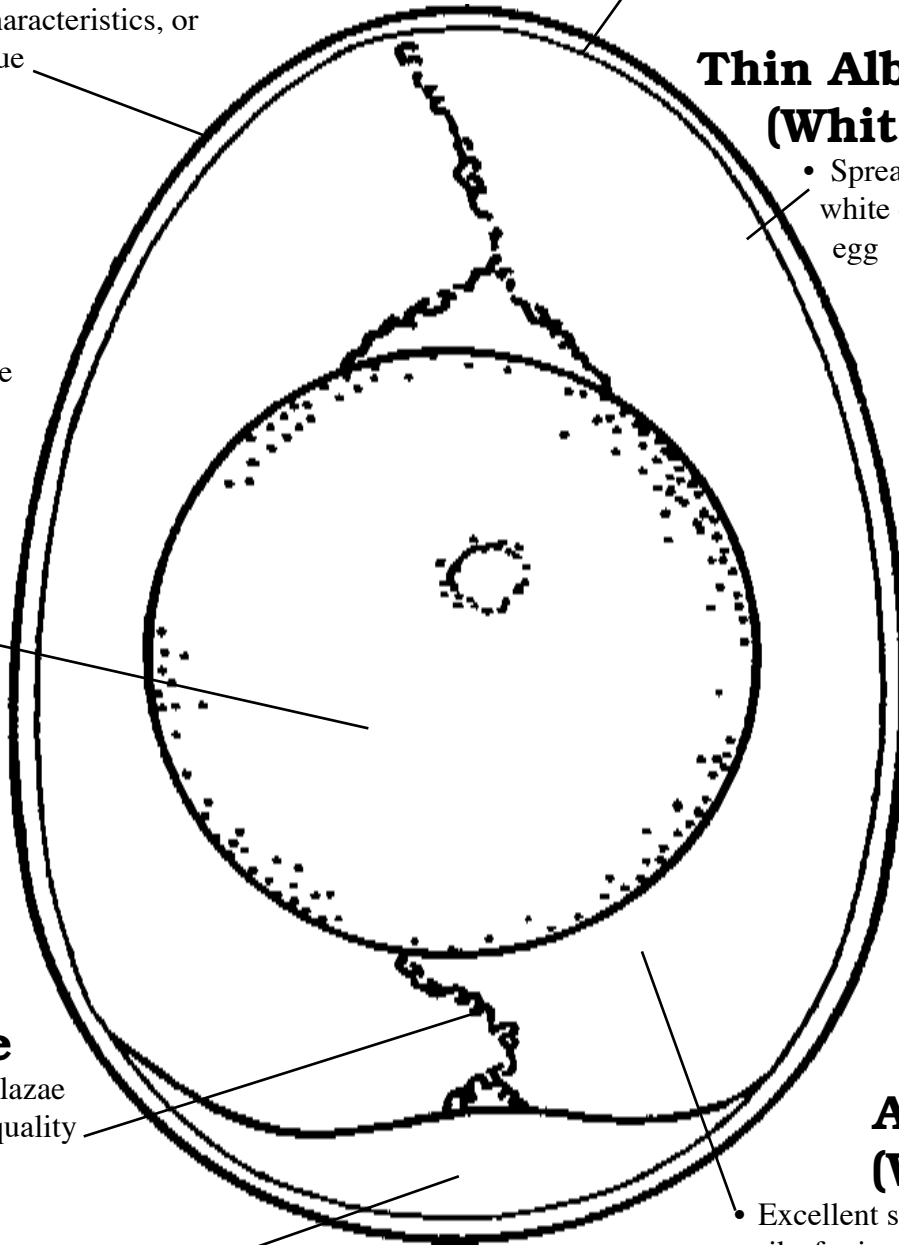

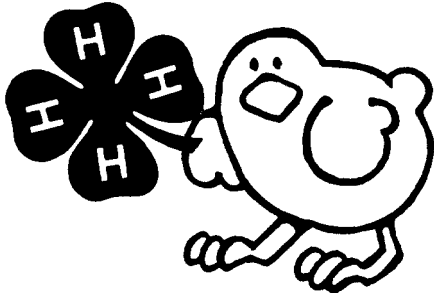

# A Natural Wonder

Name \_\_\_\_\_

- 
- Outer covering of egg, composed of calcium carbonate
  - Color does not affect quality, cooking characteristics, or nutritional value

- 
- Color varies with feed of the hen, but doesn't indicate nutritional content
  - Major source of vitamins, minerals, and fat

- 
- Indicator of high quality

- 
- Increases in size with age

- 
- Provide protective barrier against bacteria

- 
- Spreads around thick white of high quality egg

- 
- Excellent source of riboflavin and protein
  - Stands higher and spreads less than thin white in high quality eggs
  - Thins and becomes indistinguishable from thin white in low-quality eggs

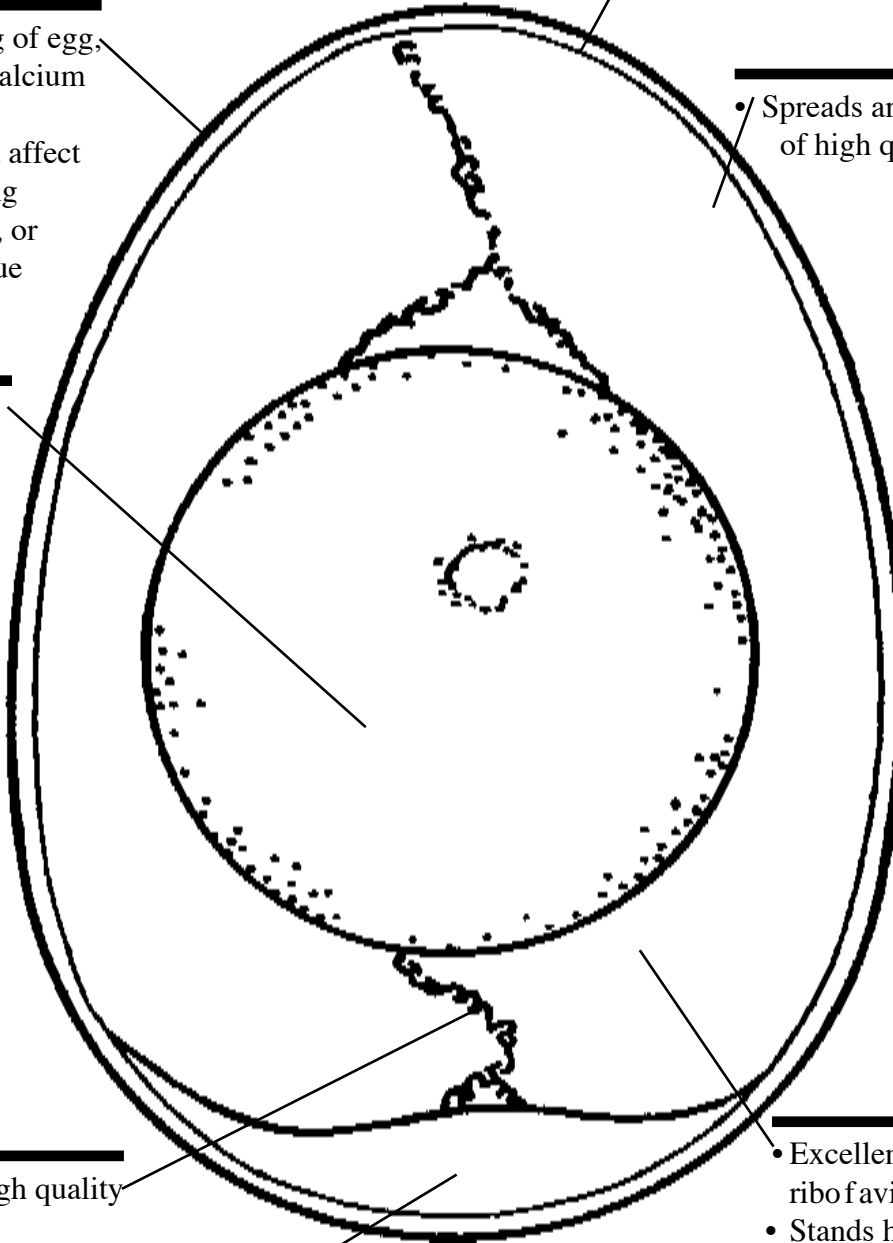

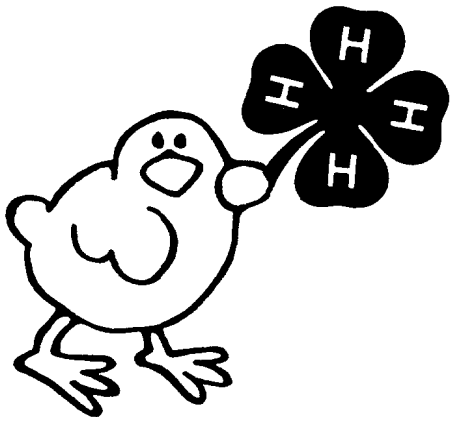

# Daily Food Intake

Name \_\_\_\_\_

	Day 1	Day 2
<b>Breakfast</b>		
<b>Lunch</b>		
<b>Supper</b>		
<b>Snacks</b>		





# MyPyramid <sup>For Kids</sup>

Eat Right. Exercise Have Fun.

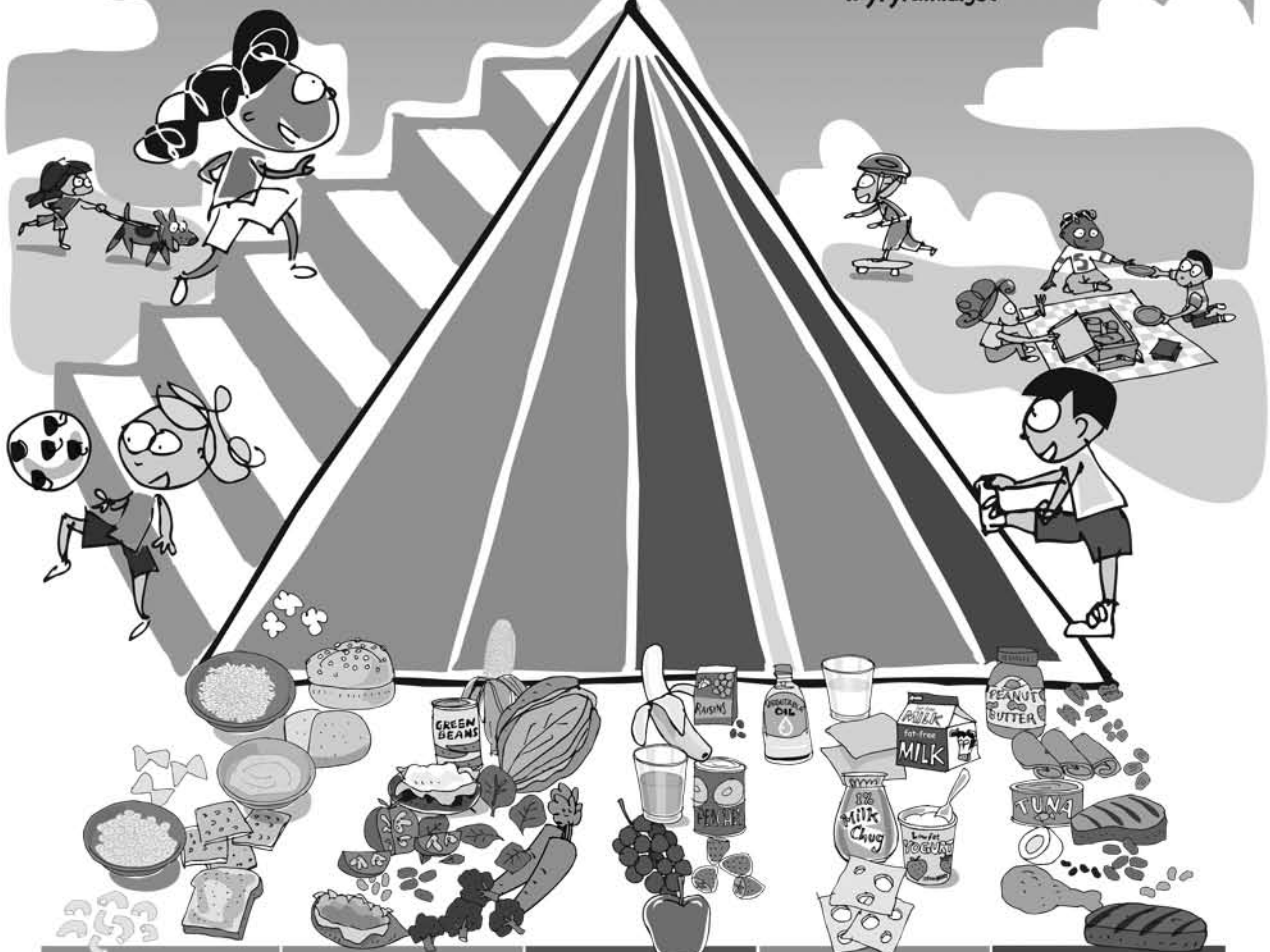
MyPyramid.gov

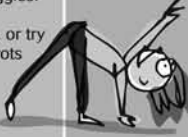

<b>Grains</b> Make half your grains whole	<b>Vegetables</b> Vary your veggies	<b>Fruits</b> Focus on fruits	<b>Milk</b> Get your calcium-rich foods	<b>Meat &amp; Beans</b> Go lean with protein
<p>Start smart with breakfast. Look for whole-grain cereals.</p> <p>Just because bread is brown doesn't mean it's whole-grain. Search the ingredients list to make sure the first word is "whole" (like "whole wheat").</p>	<p>Color your plate with all kinds of great-tasting veggies.</p> <p>What's green and orange and tastes good? Veggies! Go dark green with broccoli and spinach, or try orange ones like carrots and sweet potatoes.</p> 	<p>Fruits are nature's treats – sweet and delicious.</p> <p>Go easy on juice and make sure it's 100%.</p>	<p>Move to the milk group to get your calcium. Calcium builds strong bones.</p> <p>Look at the carton or container to make sure your milk, yogurt, or cheese is lowfat or fat-free.</p> 	<p>Eat lean or lowfat meat, chicken, turkey, and fish. Ask for it baked, broiled, or grilled – not fried.</p> <p>It's nutty, but true. Nuts, seeds, peas, and beans are all great sources of protein, too.</p>

For an 1,800-calorie diet, you need the amounts below from each food group. To find the amounts that are right for you, go to MyPyramid.gov.

<b>Eat 6 oz. every day;</b> at least half should be whole	<b>Eat 2 1/2 cups every day</b>	<b>Eat 1 1/2 cups every day</b>	<b>Get 3 cups every day;</b> for kids ages 2 to 6, it's 2 cups	<b>Eat 5 oz. every day</b>
--	---------------------------------	---------------------------------	---	----------------------------

**Oils** Oils are not a food group, but you need some for good health. Get your oils from fish, nuts, and liquid oils such as corn oil, soybean oil, and canola oil.

<p><b>Find your balance between food and fun</b></p> <ul style="list-style-type: none"> <li>Move more. Aim for at least 60 minutes everyday, or most days.</li> <li>Walk, dance, bike, rollerblade – it all counts. How great is that!</li> </ul> 	<p><b>Fats and sugars – know your limits</b></p> <ul style="list-style-type: none"> <li>Get your fat facts and sugar smarts from the Nutrition Facts label.</li> <li>Limit solid fats as well as foods that contain them.</li> <li>Choose food and beverages low in added sugars and other caloric sweeteners.</li> </ul>
---	---



USDA is an equal opportunity provider and employer.



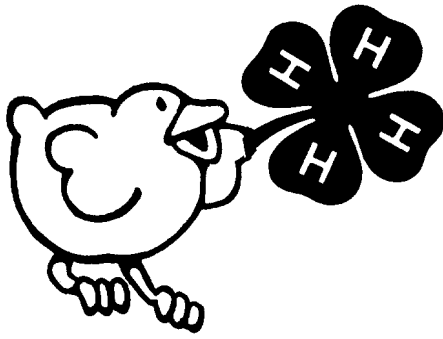

# Eggstra Math

Name \_\_\_\_\_

Read each problem carefully. Show your work below the crack in the shell. Remember to label your answers.

There are  
12 eggs in a dozen.  
How many eggs  
are in 2 dozen?  
3 dozen?  
 $4\frac{1}{2}$  dozen?

If medium  
eggs are on sale  
for 49 cents a  
dozen, how much  
will 3 dozen  
eggs cost?

Safeway sold  
1,488 eggs on  
Wednesday and  
1,548 eggs on Friday.  
How many more did  
they sell on Friday?

How many  
dozen eggs can  
Andrew buy if they  
sell for 66 cents a dozen  
and he has \$2? Will  
he receive any change  
back? If so, how much?

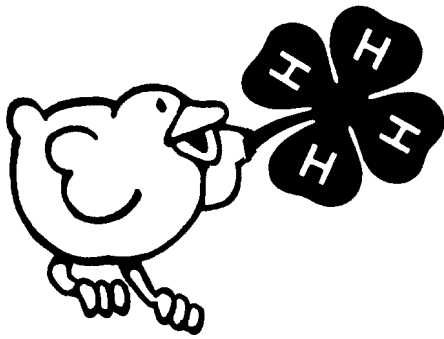

# Eggstra Math

Name ANSWER KEY

Read each problem carefully. Show your work below the crack in the shell. Remember to label your answers.

There are 12 eggs in a dozen. How many eggs are in

2 dozen? **24**  
3 dozen? **36**  
4<sup>1</sup>/<sub>2</sub> dozen? **54**

$$\begin{array}{r} 12 \\ \times 2 \\ \hline 24 \end{array}$$
$$\begin{array}{r} 12 \\ \times 3 \\ \hline 36 \end{array}$$
$$\begin{array}{r} 12 \\ \times 4 \\ \hline 48 \\ + 6 \\ \hline 54 \end{array}$$

If medium eggs are on sale for 49 cents a dozen, how much will 3 dozen eggs cost?

$$\begin{array}{r} \$0.49 \\ \times 3 \\ \hline \$1.47 \end{array}$$

Safeway sold 1,488 eggs on Wednesday and 1,548 eggs on Friday. How many more did they sell on Friday?

$$\begin{array}{r} 1548 \\ - 1488 \\ \hline 60 \text{ EGGS} \end{array}$$

How many dozen eggs can Andrew buy if they sell for 66 cents a dozen and he has \$2? Will he receive any change back? If so, how much?

$$\begin{array}{r} \$0.66 \\ \times 3 \\ \hline \$1.98 \end{array}$$

3 DOZEN

$$\begin{array}{r} \$2.00 \\ - 1.98 \\ \hline \text{YES} - 2\phi \end{array}$$

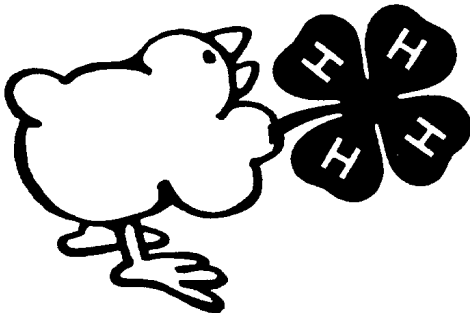

# More Eggstra Math

Name \_\_\_\_\_

Read each problem carefully. Show your work below the egg. Remember to label your answers.

Marvin delivers eggs to grocery stores. He delivered 326 dozen to Roth's IGA, 450 dozen to Fred Meyer, and 298 dozen to Albertsons. How many dozen eggs did he deliver in all?

There are 80 calories in a large egg. If Mrs. Shell eats three eggs, how many calories did she gain?

Mike and Terry are stacking egg cartons. Mike stacked 136 cartons and Terry stacked 98 cartons. How many more does Terry need to stack to have more than Mike?

Amy wants to cook breakfast for herself and six guests. She will fry two eggs for each person. How many eggs will she need to fry?

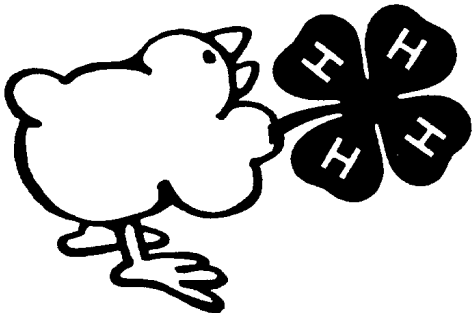

# More Eggstra Math

Name ANSWER KEY

Read each problem carefully. Show your work below the egg. Remember to label your answers.

Marvin delivers eggs to grocery stores. He delivered 326 dozen to Roth's IGA, 450 dozen to Fred Meyer, and 298 dozen to Albertsons. How many dozen eggs did he deliver in all?

1,074 EGGS

$$\begin{array}{r} 326 \\ 450 \\ + 298 \\ \hline 1,074 \end{array}$$

There are 80 calories in a large egg. If Mrs. Shell eats three eggs, how many calories did she gain?

240 CALORIES

$$\begin{array}{r} 80 \\ \times 3 \\ \hline 240 \end{array}$$

Mike and Terry are stacking egg cartons. Mike stacked 136 cartons and Terry stacked 98 cartons. How many more does Terry need to stack to have more than Mike?

38 EGG CARTONS

$$\begin{array}{r} 136 \\ - 98 \\ \hline 38 \end{array}$$

Amy wants to cook breakfast for herself and six guests. She will fry two eggs for each person. How many eggs will she need to fry?

14 EGGS

$$\begin{array}{r} 7 \\ \times 2 \\ \hline 14 \end{array}$$

# Separation Experiment

## Making Meringue

### Discussion

The white of an egg is the albumen. It surrounds the yolk in four layers and contains half the protein of the egg, some of the minerals and vitamins, a large quantity of water, and a little fat.

Before egg whites are beaten, they contain curled-up molecules of protein. Beating changes the molecules by unrolling them until they resemble stretched out fibers. Still attracted to each other, the thread-like molecules form a three-dimensional network. In this structure, the molecules trap the air beaten into the egg white. When cooked, the molecules become rigid, making the structure permanent.



**Molecules Before Beating**

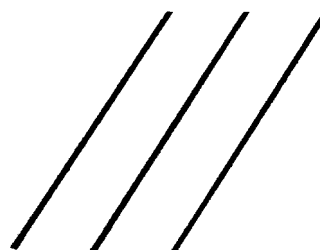

**Molecules After Beating**

### Classroom Demonstrations

1. Separate the whites from several room temperature eggs and beat them in front of the class. You may wish to have some students help you separate the whites from the yolks. Before beating, try to get the students to guess how long it will take for the whites to “whip up.” Try the experiment again with eggs kept in the refrigerator. Have students determine if temperature has an effect on the expansion of egg whites.
2. Use a clear glass beaker to show what happens when egg whites are boiled in muddy water. Have students watch as the albumen coagulates, trapping the impurities within it.

# Lesson Three

## Embryology

### Subject Area

Science/Language Arts/Math

### Objective

- Be able to identify the two ways in which eggs are hatched (incubator and hen)
- Be able to describe incubator conditions needed for a healthy chick to hatch

### 4-H Life Skills

Learning to Learn, Leading Self and Others, Relating to Self and Others,  
Communicating with Others

### Suggested Grade Level

4–5

## Background

### Incubators

There are two types of incubators, still-air and forced-draft. The still incubator can incubate eggs in only one layer. It has no fan, and must maintain a temperature of 102°F at the top of the eggs. The forced-draft incubator has a fan, is multi-layer, and the temperature must be maintained at 99.5°F.

### Hatching

Eggs are hatched in two different ways—by a broody hen or by an incubator. Today, however, very few chicks for commercial use are hatched by hens. It would be impossible to raise the millions and millions of new chicks needed every year by hatching a few eggs at a time under hens. Instead, professional hatchery-persons and poultry breeders use huge electric incubators that can hatch thousands of eggs at a time.

### Egg Tooth

The hard white spot on the tip of the chick's beak. It is used to pip (break or chip) and crack the shell during hatching.

### Embryology

A science that deals with the growth and development of an embryo to a chick inside an egg.

### Step By Step

#### Day 3

The body is shaped like a backwards question mark surrounded by blood vessels in the yolk sac. The head and heart begin to form.

#### Day 4

All the organs (digestive tract, nervous system, etc.) are present.

**Day 5**

The face and nasal parts begin to take shape.

**Day 6**

The beak begins to form. The brain is present but without a skull. The eyes have formed, but without eyelids. Leg and wing buds are present. All parts of the chick have now begun to develop.

**Day 9**

The chick is complete except for feathers and growth.

**Day 12**

Eyelids now cover the eyes. Hair like feathers cover the skin. Chicks begin to swallow the albumen as a protein source.

**Day 14**

The embryo moves itself in the shell so its head is by the air cell at the large end of the egg.

**Day 15**

The body is covered with down feathers. The egg tooth is formed. The feet now have toenails.

**Day 16**

The albumen is almost gone—the yolk continues as a food source for the chick.

**Day 17**

The head is under the right wing and the beak is turned toward the air cell at the large end of the shell. At the end of this day, humidity is increased. The incubator should now be kept closed until the hatched chicks are dried off and ready to be moved.

**Day 18**

The embryo is almost full-grown and ready to begin the hatching process.

**Day 20**

The yolk sac is drawn into the embryo's body; it will need this food for energy during the hatching process and its first few days of life. The embryo now takes up all the space except the air cell. It will pip the shell membrane with its egg tooth, and fill its lungs with oxygen from the air cell.

**Day 21**

Hatching time! The embryo's normal position before hatching is to have its head under its right wing at the large end of the egg, with its beak pointing at the air cell. The embryo uses its egg tooth to pip (break or chip) almost all the way around the inside of the shell. Then, by kicking, it emerges out of the shell all wet and tired. For a few hours it will need to rest and dry off into a fluffy chick. It needs to be kept in the warm incubator until completely dry.

## Temperature

Still-air incubators (no fan) need to be maintained at about 102°F at the top of the eggs. In this type of situation the top of the eggs will be warmer than the bottom of the eggs. Forced-draft incubators (with fan) must be maintained at a temperature of about 99.5°F. The temperature in these incubators is the same throughout. Over-heating will speed up the rate of development, causing abnormal embryos, lower hatchability, or early death.

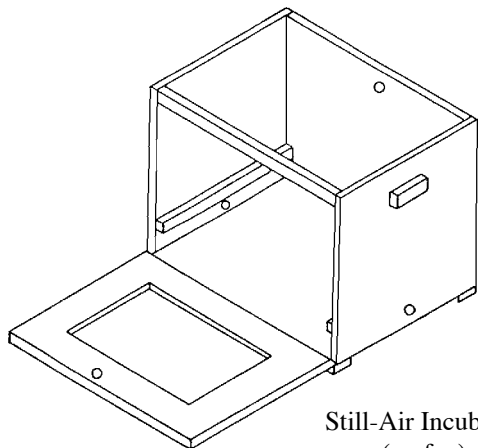

Still-Air Incubator  
(no fan)  
Temp: 102°F (top of egg)

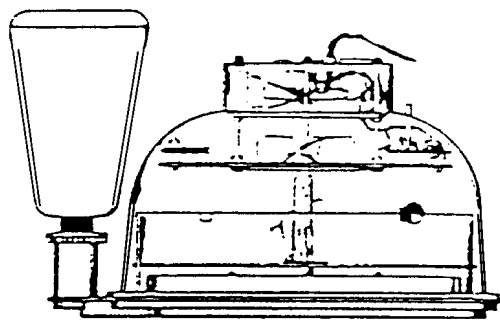

Forced-Draft Incubator  
(with fan)  
Temp: 99–100°F

## Humidity

Humidity is important to control the amount of water lost from an incubating egg, and thus for normal embryo development. The relative humidity of air within the incubator for the first 18 days should be about 60 percent. A variation of 5 to 10 percent probably will not hurt. Low humidity causes too much loss of water from the egg, while high humidity does not allow enough water loss. In both cases, hatchability is reduced. A pan of water in the incubator will ensure moisture in the air. The eggs, however, should not come into direct contact with the water.

## Turning the Eggs

Turning prevents the embryo from sticking to the shell. Good results can be obtained by turning the eggs the first thing in the morning, again at noon, and the last thing at night. Turn them at least three times a day (preferably five to seven times a day). Always turn the eggs an odd number of times each day so at night the chick will be lying differently than the night before. Also, turn them a different direction each turn. They only need to be turned until the end of the 17th day. After that the embryo can move enough on its own without sticking to the shell.

## Ventilation

As the embryo grows, it uses oxygen and gives off carbon dioxide. Thus, efficient ventilation within the incubator is required to assure an adequate supply of oxygen in the air, and to keep the carbon dioxide low.

## Resources

PNW 478, *Hatching Small Numbers of Eggs*, Oregon State University Extension Service, reprinted 1995.

## Materials

1. Worksheets K, L, and M
2. Transparency C
3. Certificate—"The Egg ceptional Award"

## Procedure

1. Discuss the conditions necessary for proper incubation (found in the background section of the lesson)
  - a. temperature
  - b. humidity
  - c. turning the eggs
  - d. ventilation
2. Have students complete worksheet K, then review them together.
3. Discuss the development of the embryo using Transparency C and the background information.
4. Have students make a booklet from Worksheets L.
5. Duplicate and complete certificate "The Egg ceptional Award" for each student who completes this unit.

## Eggstra Activities

- Have students use the information from this list to make a graph. Use the least number of days when an approximation is given.

<b>Bird</b>	<b>Days</b>
Chicken	21
Turkey	28
Duck	28
Muscovy Duck	33–35
Goose	28–35
Guinea	26–28
Pigeon	16–18
Ring Necked Pheasant	23–25
Bobwhite Quail	24
Japanese Quail	17–18
Chukar Partridge	24
Peafowl	28

- Have students copy and illustrate this poem.

## Baby Chick

Peck

peck

peck

on the warm brown egg.

OUT comes a neck.

OUT comes a leg.

How

does

a chick,

Who's not been about,

discover the trick

of how to get out?

*by Aileen Fisher*

Taken from: *Widening Circles: Level 8*  
Teachers Edition,  
Harcourt Brace Jovanovich  
©1979 HBJ, Inc.

- Assign Worksheet M to be completed at home or in groups during class.

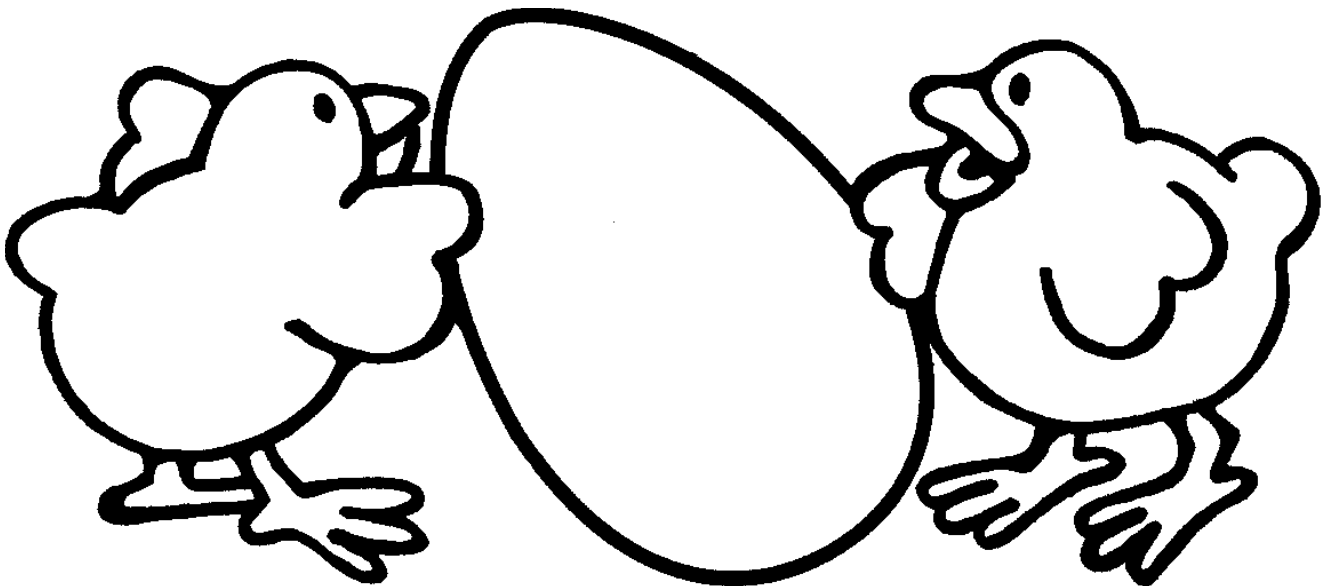

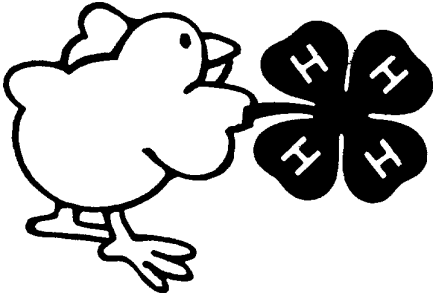

# Incubation

Name \_\_\_\_\_

Complete each sentence below by circling the correct answer.

1. A human-made container for hatching eggs is \_\_\_\_\_ .  
an aquarium                      an incubator                      a thermometer
2. Embryology is the study of the development of \_\_\_\_\_ .  
an embryo                      an insect                      a reptile
3. It takes \_\_\_\_\_ days to hatch chicken eggs.  
12                      31                      21
4. The temperature in the incubator is measured with a \_\_\_\_\_ .  
ruler                      thermometer                      scale
5. Water is kept in the incubator because the eggs need \_\_\_\_\_ .  
ventilation                      moisture                      warmth
6. As the embryo grows it uses \_\_\_\_\_ and gives off carbon dioxide.  
oxygen                      humidity                      moisture
7. Good \_\_\_\_\_ is important because the embryo needs oxygen.  
ventilation                      carbon dioxide                      humidity
8. The eggs should \_\_\_\_\_ be put directly into the water pan.  
always                      sometimes                      never
9. The eggs in the incubator should be turned \_\_\_\_\_ times a day.  
one                      two                      three

10. Turning the eggs prevents the embryo from \_\_\_\_\_ .  
getting too big                      sticking to the shell                      sleeping
11. The eggs in the incubator should always be handled \_\_\_\_\_ .  
gently                                      roughly                                      with gloves
12. The embryo pips (breaks) open the shell with its \_\_\_\_\_ .  
egg tooth                                      feet                                      wings
13. After the chick hatches, it will be \_\_\_\_\_ .  
ready to play                                      learning to fly                                      wet and tired
14. The \_\_\_\_\_ is the main source of food for the growing embryo.  
chalazae                                      yolk                                      albumen

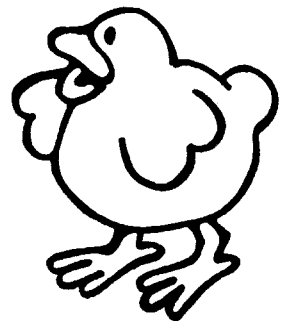
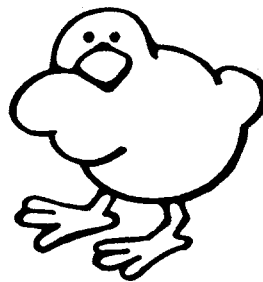
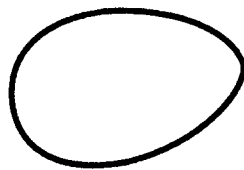
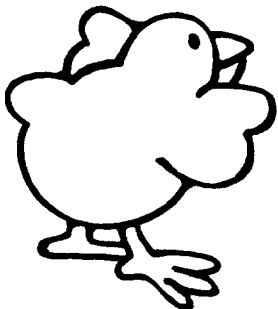

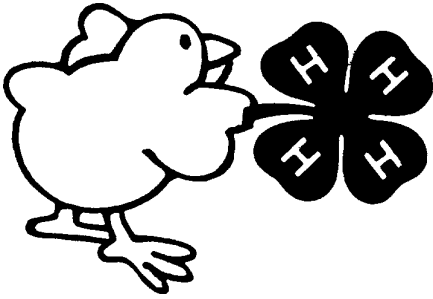





# Incubation

Name ANSWER KEY

Complete each sentence below by circling the correct answer.

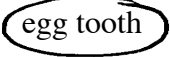
1. A human-made container for hatching eggs is \_\_\_\_\_ .  
an aquarium                                            a thermometer
2. Embryology is the study of the development of \_\_\_\_\_ .  
 an embryo                      an insect                      a reptile
3. It takes \_\_\_\_\_ days to hatch chicken eggs.  
12                      31                       21
4. The temperature in the incubator is measured with a \_\_\_\_\_ .  
ruler                                            scale
5. Water is kept in the incubator because the eggs need \_\_\_\_\_ .  
ventilation                       moisture                      warmth
6. As the embryo grows it uses \_\_\_\_\_ and gives off carbon dioxide.  
 oxygen                      humidity                      moisture
7. Good \_\_\_\_\_ is important because the embryo needs oxygen.  
                      carbon dioxide                      humidity
8. The eggs should \_\_\_\_\_ be put directly into the water pan.  
always                      sometimes                       never
9. The eggs in the incubator should be turned \_\_\_\_\_ times a day.  
one                      two                       three

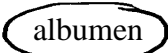
10. Turning the eggs prevents the embryo from \_\_\_\_\_ .  
getting too big            sleeping
11. The eggs in the incubator should always be handled \_\_\_\_\_.  
 gently      roughly      with gloves
12. The embryo pips (breaks) open the shell with its \_\_\_\_\_.  
 egg tooth      feet      wings
13. After the chick hatches, it will be \_\_\_\_\_.  
ready to play      learning to fy      
14. The \_\_\_\_\_ is the main source of food for the growing embryo.  
chalazae      yolk       albumen

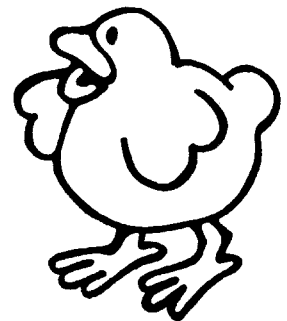
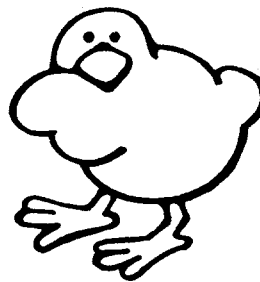
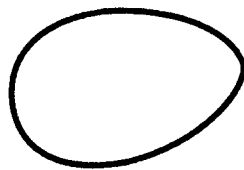
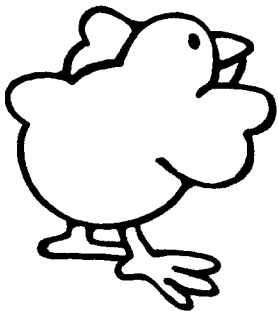

# The Developing Embryo

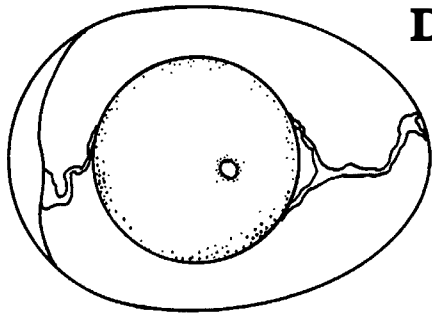

**Day 1**

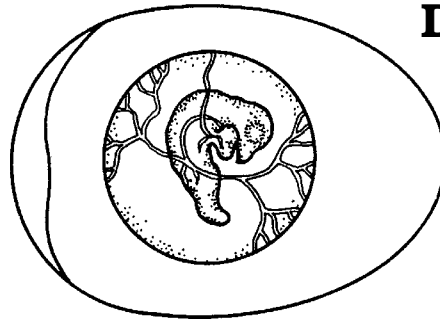

**Day 3**

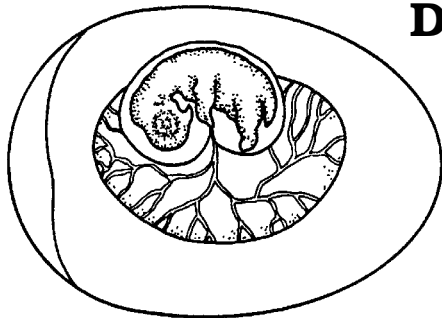

**Day 6**

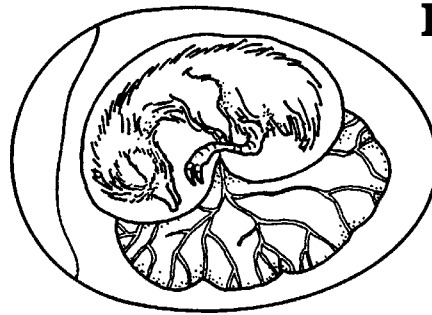

**Day 13**

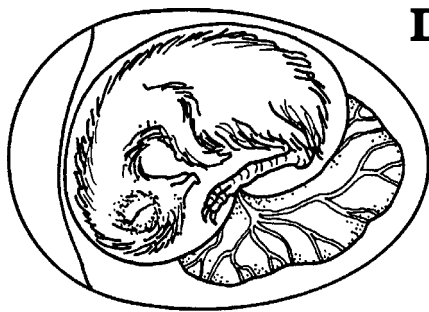

**Day 16**

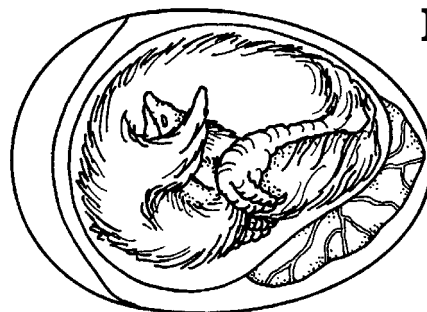

**Day 19**



**Day 21**

Adapted from *Copycat*

# What's Inside?

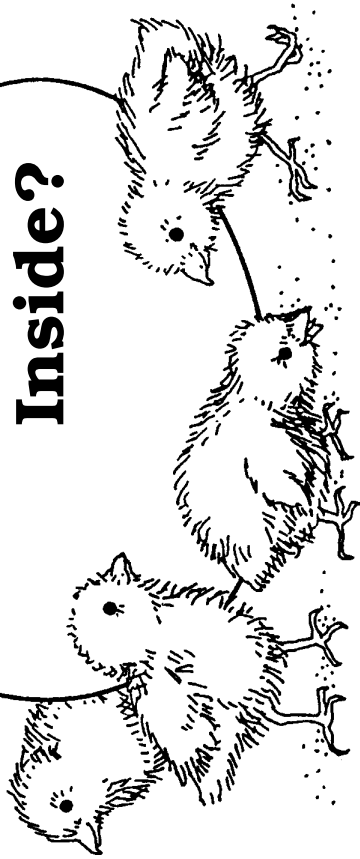

What is inside of this little eggshell?  
A new baby chick! This story will tell.

## Day 1

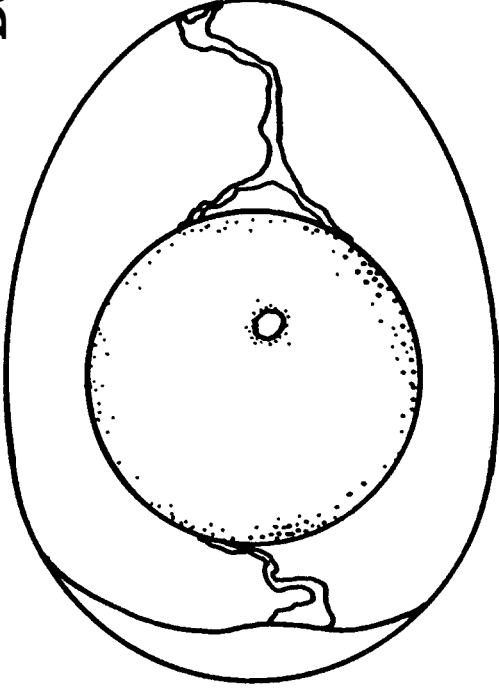

Baby chick, baby chick, when will you hatch?  
Did you begin with this little white patch?

## Day 3

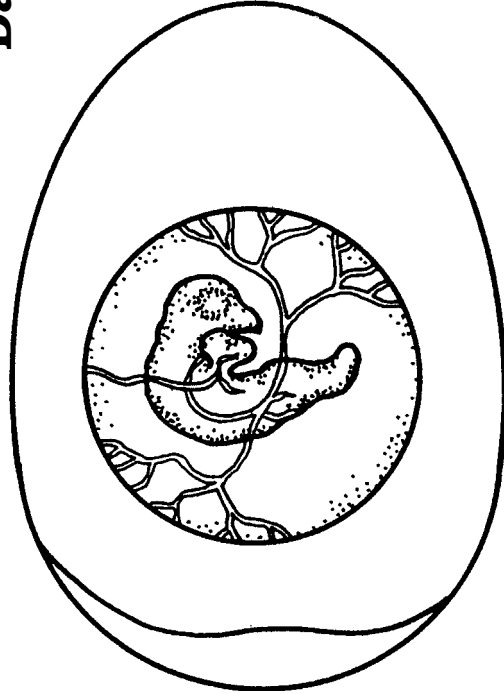

You're very tiny but warm as can be.  
Your heart and your head we begin to see.

## Day 6

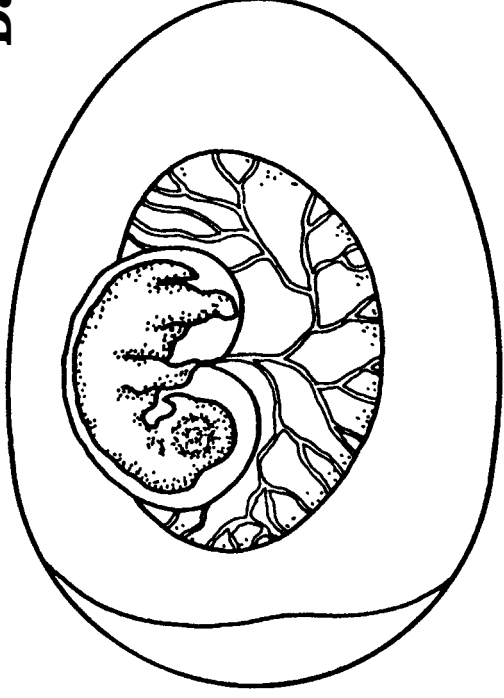

More days for growing, almost a week.  
You now have two wings, two legs, and a beak.

**Day 13**

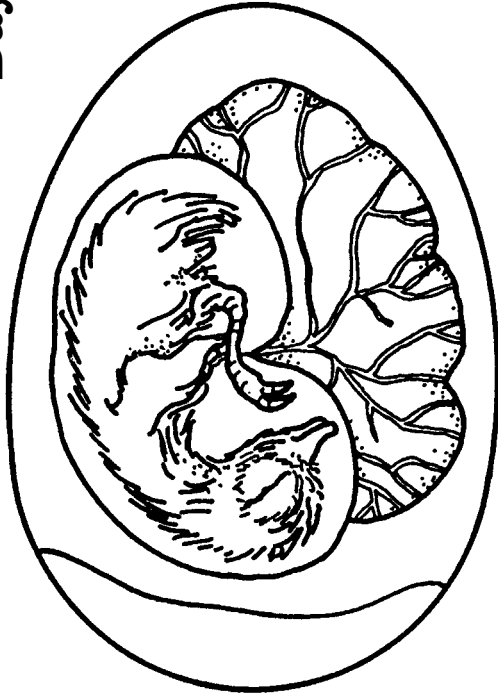

Soon you have feathers, and claws on your toes.  
Oh, my, how fast a new baby chick grows!

**Day 16**

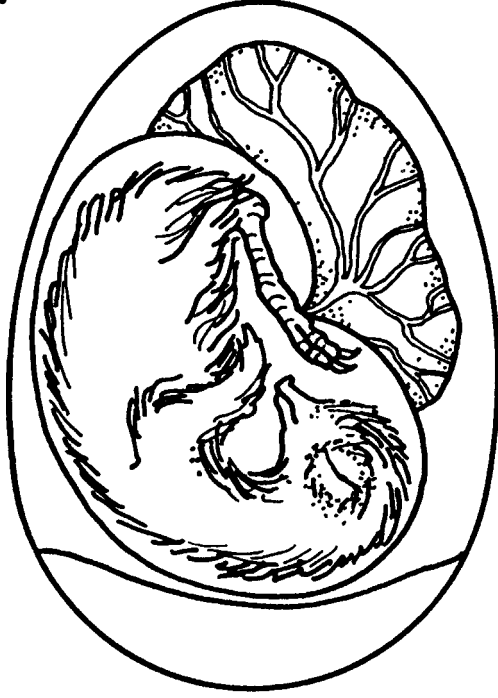

Bigger and bigger you grow every day.  
Your food's almost gone. Not long can you stay.

**Day 19**

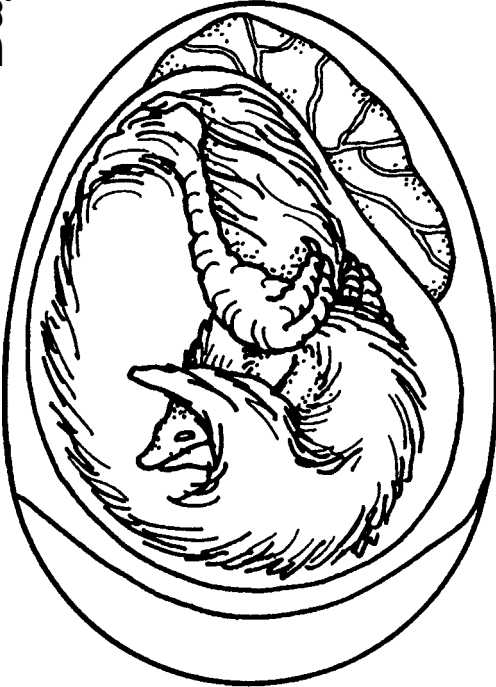

This shell is too small. You're too big to fit.  
You're just about ready to hatch out of it.

**Day 21**



Peck for awhile, then take a short sleep.  
You work very hard and you're out. Peep! Peep!

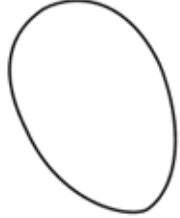
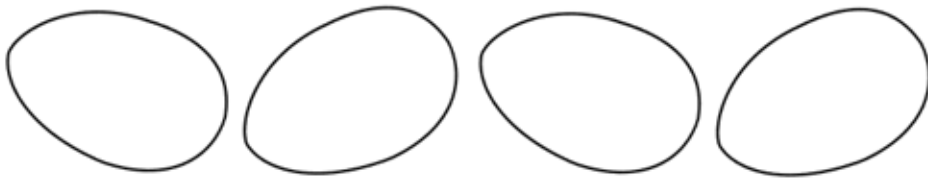

# **The Egg-ceptional Award**

**Presented To**

---

**On This Day**

---

**For**

---

**Teacher**

---

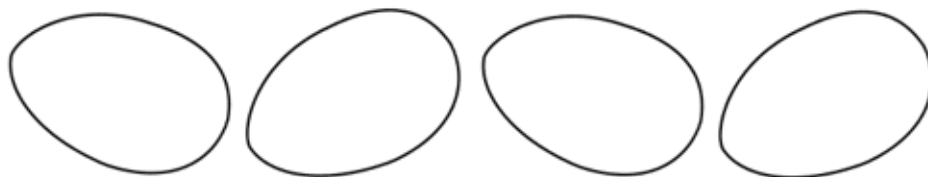

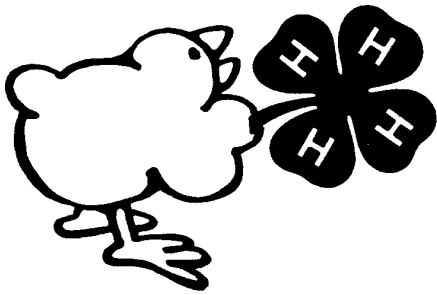

# Egg-U-Bation

Name \_\_\_\_\_

The incubator allows us to hatch millions and millions of chicks each year. Can you find what makes an incubator work?

(words can be spelled vertically, horizontally, diagonally, backward, and forward)

B G Q E C R T D X V E Y S F W Z  
 G R W R O T A T I O N H K I A M  
 J O K U L A B U M J B N V L T O  
 F U P T H E R M O M E T E R C Y  
 E P H S R G P C Q I D O N N H T  
 S W T I U X W D V E C F T Y F I  
 Z O B O G J P E L U K Z I Y U C  
 Q R R M V B M G D I E T L A L I  
 S K W Z A I Z G O W A D A W N R  
 X V G C T C W S M B N J T X E T  
 W H U I W M K N T J E S I R S C  
 A J C D B Q C N E G Y X O X S E  
 R E T A B X K G X K O J N H B L  
 M L Q S R Y F J R P Z W F D G E  
 T N K P R E Q S T U D E N T S J  
 H A O M Y T I D I M U H C I E Z

## Check List

Eggs	Time	Ventilation	Moisture
Thermometer	Rotation	Groupwork	Care
Watchfulness	Electricity	Humidity	Warmth
	Students	Oxygen	

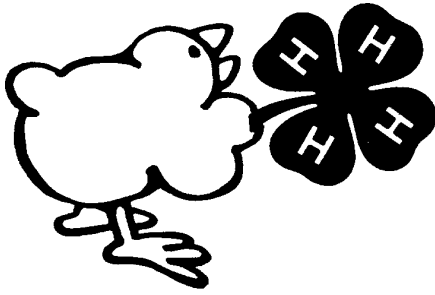

# Egg-U-Bation

Name ANSWER KEY

The incubator allows us to hatch millions and millions of chicks each year. Can you find what makes an incubator work?

(words can be spelled vertically, horizontally, diagonally, backward, and forward)

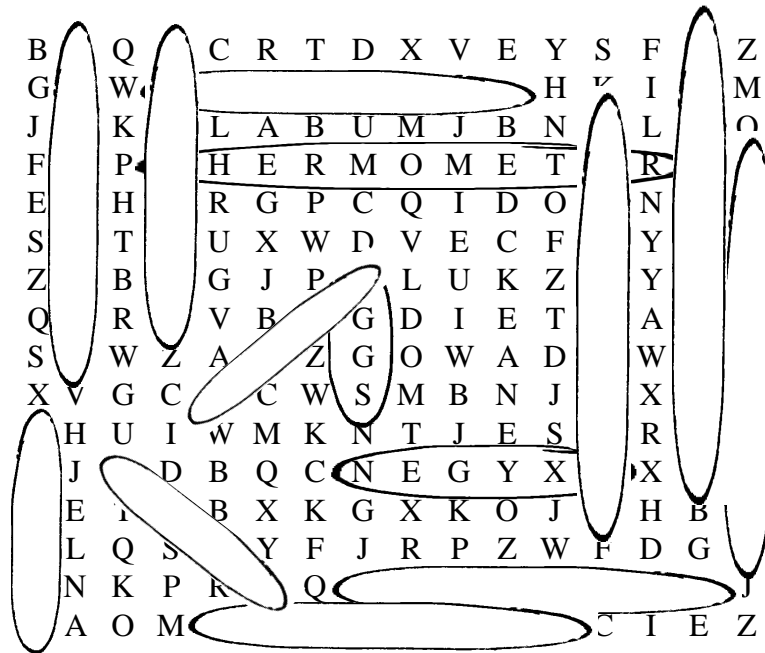

## Check List

- |              |             |             |          |
|--------------|-------------|-------------|----------|
| Eggs         | Time        | Ventilation | Moisture |
| Thermometer  | Rotation    | Groupwork   | Care     |
| Watchfulness | Electricity | Humidity    | Warmth   |
|              | Students    | Oxygen      |          |

# Lesson Four

## Experiments

### Subject Area

Science

### Objectives

- Be able to use the scientific methods of observing and recording during an experiment
- Be able to draw conclusions after the experiment

### 4-H Life Skills

Learning to Learn, Leading Self and Others, Communicating with Others

### Suggested Grade Level

4-5

## Background

1. A reliable way to tell the difference between raw and hard-cooked eggs is by spinning; the raw egg is slower because the liquid sloshing inside the egg creates resistance as it hits the walls.
2. The hard-cooked egg spins faster since it's all spinning together.
3. The hard-cooked egg will roll farther and faster than the raw one.

## Experiment One

### Materials

1. 4 raw eggs
2. 4 hard-cooked eggs
3. Flashlight
4. Worksheet N

### Procedure

Label one hard cooked egg "A" and one raw egg "B." Set up the eggs and the flashlight in a darkened corner of the classroom. Send the students to the corner to complete Experiment One on worksheet N.

# Experiment Two

## Materials

1. Several raw eggs of different grades
2. Six to eight books
3. Foam padding or two halves of a racquetball
4. Long board
5. Worksheet O

## Procedure

1. Discuss how easily eggs seem to break. Ask how many students have accidentally broken eggs. Then ask for suggestions on how many pounds a raw egg can hold before cracking. Write these on the chalkboard.
2. Gather the students around the experiment so everyone can see the materials. Keep the room quiet so they can hear the egg crack.
3. For each egg, jot down its size, grade, and shell color on the chalkboard. The students will need the data to fill in the chart for the strongest egg.
4. Next, assemble materials as shown in the illustration below. Support one end of the board with books at a height of about 1 foot. On the opposite end, sandwich an egg end to end (cushioned between two pieces of foam or the halves of a racquetball) between two books. Make sure the ends of the board are level.
5. Once assembled, have a smaller student walk across the board. If the egg does not break, try a larger student. Have students estimate the amount of pressure the egg withstood.
6. Repeat the experiment with the other eggs. Was there much difference? Discuss why. (The size of the egg and the thickness of the shell affects its strength.)
7. Finally, ask the students to fill out the certificate on Worksheet O using the data for the strongest egg.

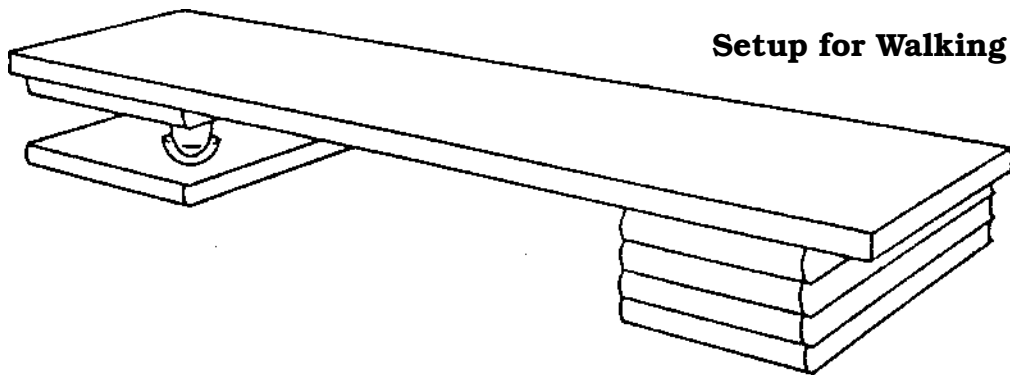

**Setup for Walking on Eggs**

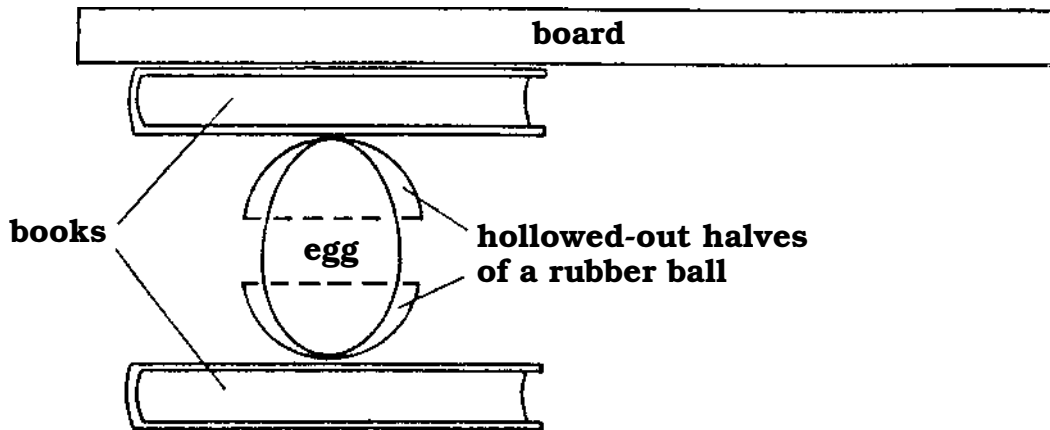

## Additional Facts

1. **Cosmetic**—Egg white has long been used as a facial. Egg yolk is used in shampoos and conditioners.
2. **Animal Feed**—Both shells and interiors of eggs are used.
3. **Experimental Uses**—Egg white is used as a protein reference in feeding laboratory animals. Egg yolk and egg products are used in laboratories as a medium for the growth of microorganisms.

## Eggstra Activities

- Have the students cut out all clear eggs on Worksheet P. Have them match the blackened eggs to an antonym and the clear eggs to a synonym on Worksheet Q. Check to see that all students have correct matches. Have them fold up the wide end of each egg and paste the eggs at the narrow ends to form a fip up activity they can practice at home.
- Have students see if they can balance an egg on one end. After several attempts, have them prick the egg at one end with a needle. This will cause the yolk to break and redistribute the weight of the egg. The egg will become bottom-heavy and can be easily stood on its end.

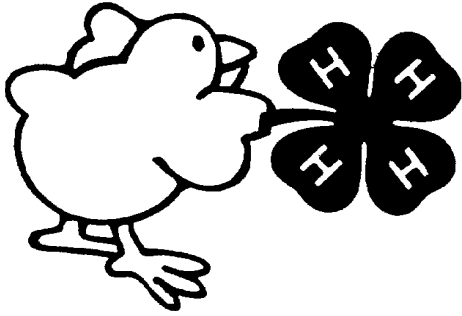

# Let's Eggs-periment

Name \_\_\_\_\_

How well do you notice details? Can you figure why something happens? These experiments will give you a chance to be a scientist. Watch what happens in each experiment and then answer the questions.

## Experiment 1

### Raw or Hard-cooked?

1. Look at both eggs closely. Do you see anything that tells you which one is raw?
2. Shake each egg carefully. Can you feel a difference? \_\_\_\_\_  
If you can, which one is raw? \_\_\_\_\_
3. Hold each egg in front of the flashlight. Does more light show through one of them? \_\_\_\_\_ If so, which one? \_\_\_\_\_
4. Spin each egg on the floor away from tables and chairs. Do they both spin the same? \_\_\_\_\_ If not, which one was slower? \_\_\_\_\_  
Do you think the slower egg is hard-cooked or raw? \_\_\_\_\_

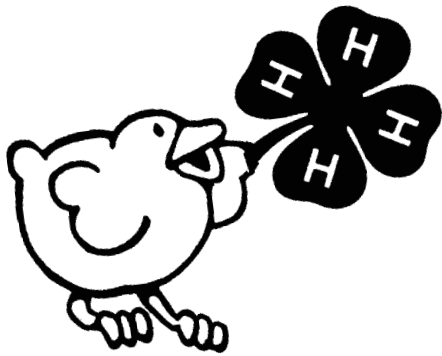

# Super Egg!

Name \_\_\_\_\_

## Official Results

**A**s a scientist and honest reporter, I am officially recording the facts of my experiment. On \_\_\_\_\_, date a test of strength was given to an egg with these characteristics:

**size** \_\_\_\_\_

**grade** \_\_\_\_\_

**shell color** \_\_\_\_\_

This egg held up until \_\_\_\_\_ pounds were put on it.

Therefore, this egg has been named "Super Egg of the Day."

Scientist \_\_\_\_\_ Date \_\_\_\_\_

Witness \_\_\_\_\_ Witness \_\_\_\_\_

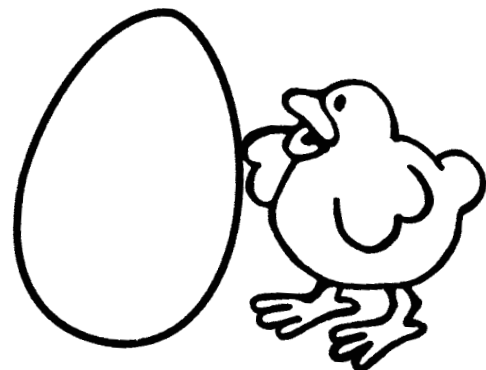

**Passive**

**Death**

**Old**

**Hen**

**Firm**

**Asleep**

**Cold**

**Moist**

**Antonyms are words that have opposite meanings. Example: big—small.**

**Synonyms are words that have similar (like) meanings. Example: noisy—loud.**

**Fowl**

**Weak**

**Feed**

**Circulate**

**Watchfulness**

**Turn**

**Break**

**Permeable**

**Dry**

**Chicken**

**Rooster**

**Care**

**Active**

**Crack**

**Awake**

**Rotate**

**Porous**

**Soft**

**Birth**

**Ventilate**

**Warm**

**Food**

**Young**

**Feeble**

# Appendix

## Support Material

For use when conducting a Chick Embryology unit where fertilized eggs are incubated and hatched.

- Incubation/Embryology Checklist
- Incubator Daily Record
- Reasons for Poor Hatches
- After the Chicks Hatch
- Questions Most Asked by Teachers
- Questions Most Asked by Students

## Follow-up Material

- Certificate of Participation
- Follow-up Worksheets
- Post Test

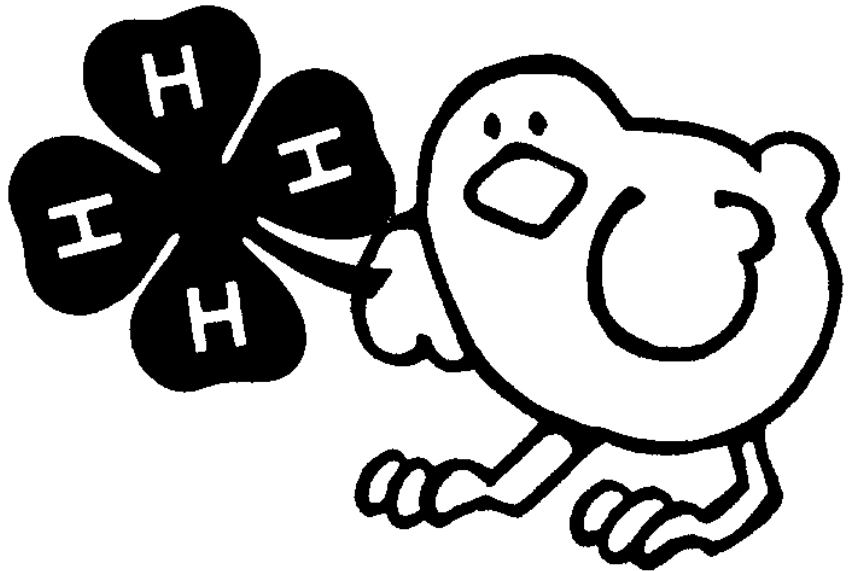

# Incubation/Embryology Checklist

## Pre-hatch Checklist

### When you receive your incubator

- Wash it thoroughly with a damp cloth using a diluted bleach solution (9 parts water : 1 part bleach), then let it dry.
- Set it up away from drafts, direct sunlight, and traffic paths.
- Regulate the temperature between 99°F to 100°F 2 or 3 days before you begin incubation of fertile eggs. Maintain room temperature between 70°F and 75°F.
- Make sure you have a reliable and accurate thermometer.
- Be sure the thermometer is placed at egg level.
- Fill rings in bottom of incubator with distilled water and keep full.

## Incubation and Hatching Checklist

- Wash your hands thoroughly before setting eggs in the incubator.
- Make sure the incubator water channels are full of water.
- Mark an “X” on one side and an “O” on the other side of each egg with a pencil.
- Best day of the week to set your fertile eggs is Tuesday or Wednesday.
- Regulate temperature between 99°F and 100°F.
- Turn your fertile eggs three times a day until the 18th day of incubation. Wash your hands thoroughly before handling the eggs. Keep records on turning the eggs.

- Eggs can be candled on day 7, 14, and 18 of the incubation period.
- On the 18th day, place a thin layer of cheesecloth over the wire rack, then place the eggs on the cheesecloth.
- Increase relative humidity in the incubator.

## **Post-hatch Checklist**

- Set up a brooder box.
- Acquire feed in advance of hatch.
- Place fresh cat litter, cedar or wood shavings in the bottom of the brooder box.
- Regulate the temperature around 95°F.
- Provide water for chicks after they are placed in the brooder box.
- Decide in advance of hatch what you will do with the baby chicks.
- After hatch, clean your incubator with a diluted bleach solution (9 parts water : 1 part bleach).

This information was adapted from material prepared by Gary S. Davis, North Carolina State University  
K.W. Koelkebeck  
Incubation-Embryology Series  
1-13-89

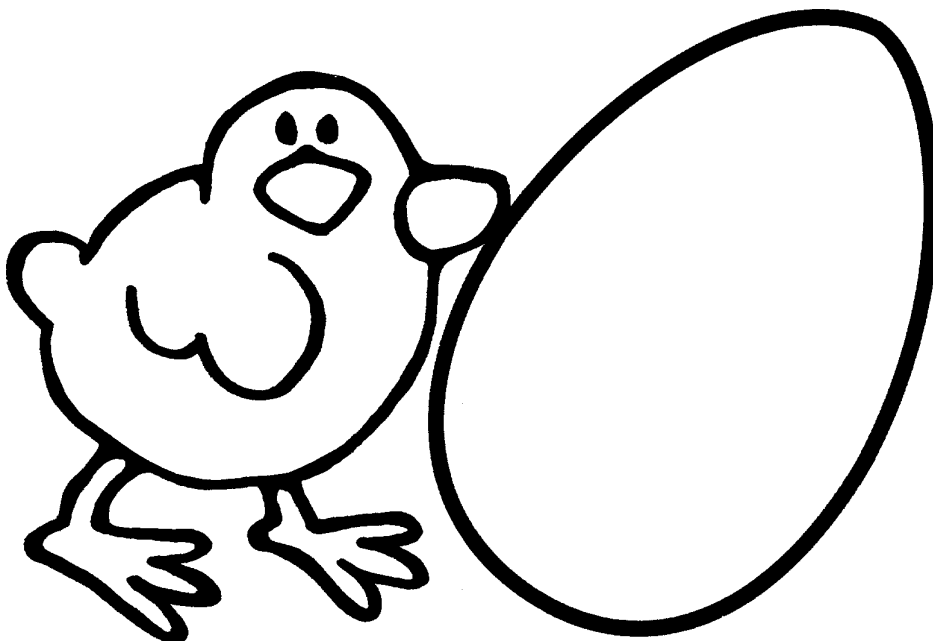



# Reasons for Poor Hatches

Poor results in hatching commonly are caused by the improper control of *temperature* or *humidity*. Improper control means the temperature or humidity is too high or too low for such a long period of time that it interferes with the normal growth and development of the embryo.

To obtain the best possible hatch, keep the correct temperature as constant as possible for the entire incubation period. There may be a fluctuation of 1 or 2 degrees, but there should not be prolonged periods of high or low temperature. High temperature is especially serious.

An incubator that is run warm will tend to produce an early hatch. One that is run cold will tend to produce a late hatch.

To obtain the proper temperature reading, place the bulb of the thermometer so it is on a level with the place where the embryos will begin to develop in the eggs. This is approximately  $\frac{1}{4}$ -inch below the top surface of the shell when the egg is on its side. This applies to chicken, duck, pheasant, quail, and other species' eggs. The bulb of the thermometer should not be in contact with an egg.

Check the thermometer! Is it accurate? An error of 1 degree for 21 days can seriously interfere with embryo growth.

To check the incubator thermometer, place the bulb next to the bulb of a clinical (the oral kind used to check body temperature) or a laboratory thermometer. Hold under lukewarm tap water and compare the readings. Make an adjustment for any error in the incubator thermometer.

A thermometer in which the mercury column is split will *not* give an accurate reading. It is no good; dispose of it.

Rarely is the humidity too high in a still-air incubator. Normally, it tends to be low. Thus, the water pan should cover at least one-half of the surface area of the incubator.

The humidity should be raised during the last 3 days of incubation. Adding another water pan or a wet sponge helps to do this. Embryos need considerable moisture to hatch properly and easily. High humidity tends to produce a late hatch; low humidity an early hatch.

**DO NOT** turn the eggs the last 3 days of incubation. The embryos are moving into hatching position and do not need to be turned. Keep the incubator closed to maintain proper temperature and humidity, but **DO NOT** seal it tightly because the embryos need oxygen.

The longer eggs are held before setting, the lower the hatchability will be. Try to set eggs before they are 10 days old.

Allow the newly hatched chicks to dry out in the incubator until they fuff up. Then place them in a brooding unit.

For additional information, refer to PNW 478, *Hatching Small Numbers of Eggs*, Oregon State University Extension Service, reprinted 1995.

# After the Chicks Hatch

Adapted from *The Avian Embryo*, Extension Bulletin 633, The Ohio Cooperative Extension Service, The Ohio State University, 1978

## Brooding Chicks for a Few Days

Live chicks may be kept for display and additional study if proper care and facilities are provided. It is important to protect, feed, and water them to ensure their comfort. Remember to find a good permanent home for the chicks after the period of classroom observation is over. If no appropriate home for the chicks can be found, it is better to destroy them than allow them to suffer and die through maltreatment.

Although there is no definite period of brooding, a maximum of 10 days is probably enough time for students to gain insights into the chicks' behavior, eating habits, etc.

## Equipment and Supplies for Brooding up to 12 Chicks

- Container approximately 28" x 25" x 14"
- Gooseneck lamp with a 60–75 watt lamp to keep chicks warm
- Shavings as litter material—large enough so chicks won't eat them
- Feed Tray—shallow yet sturdy so chicks won't upset it
- Feed—chick starter
- Waterer—closed system preferably so chicks won't step in it

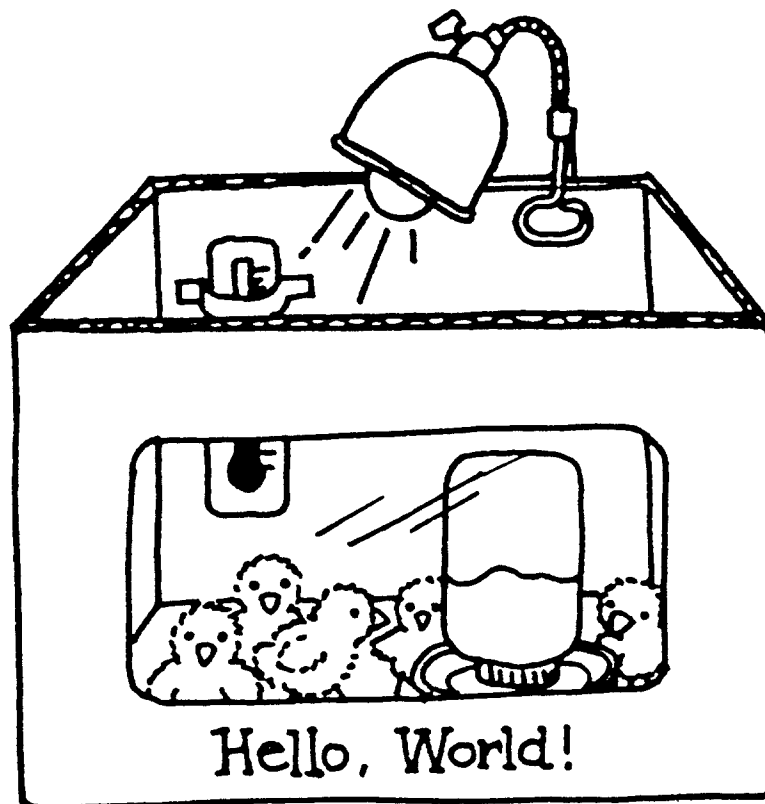

## Procedure

A simple brooding unit may be used to keep a few chicks for a short period of time. The principles of brooding are the same regardless of the number of chicks in the flock. The above figure shows a set-up of a simple brooder. The shape and quality of the container is not important as long as it is large enough to house the chicks and adequately contain the equipment.

Note the position of the lamp. Chicks must be able to get away from direct heat, so having the lamp at one end with a slightly cooler area at the other end of the container is advisable. A 60-75 watt bulb normally provides enough warmth. The neck of the lamp should be adjustable so that it can be moved closer to the chicks if they appear cold. Comfortable chicks usually are distributed evenly throughout the floor area of the brooding unit rather than clustered together.

## Ideal Temperature

<b>Age of Chicks</b>	<b>Temperature</b>
1 day to 1 week	95°F under the light bulb
1 week to 2 weeks	90°F under the light bulb

## When to Place Chicks in Brooder

Once chicks have hatched and appear dry, remove them from the incubator and place them into the brooder. It is best to wait until most of the chicks have hatched before moving them to the brooder. Disrupting the environment within the incubator can cause problems for those chicks still hatching. For example, if hatching chicks get too dry, they tend to stick to their shells, thereby lessening their chances for a successful hatch.

Remember, all domestic animals depend on human beings for survival. Make sure the chicks are properly housed, kept warm and out of drafts, and have food and water. This means having students check the brooder in the morning, at noon, and at the end of the day.

# Questions Most Often Asked by Teachers

## **1. Humidity—How do you know what's enough or too much?**

In small classroom incubators, there is no exact or precise way to measure humidity. Hygrometers do not work well in these incubators. If you have a factory-made incubator, keep water in the receptacle(s) all the time. If you have made your own incubator, use a water pan or pans equal in size to at least one half and preferably more of the incubator's floor space. During the last 3 days of incubation, place moist sponges or cloths in the incubator to increase humidity, but don't let the sponges or cloths come into contact with the eggs.

## **2. Is the Cornish breed of chickens in the English class the ones that are sold as Cornish hens?**

Not the pure Cornish. A cross of Cornish and usually White Plymouth Rocks are used to produce the Cornish hen, also called Rock Cornish and Rock Cornish Hens. Rock Cornish Hens are actually small broilers.

## **3. What breed of chickens is used for cock fighting?**

Fighting cocks come mostly from varieties of, or crosses with, the Old English breed. It should be noted that it is illegal to fight cocks in Oregon, but breeding or keeping fighting cocks is OK.

## **4. How many eggs can be set in an incubator?**

The rule of thumb is that an average "Large" egg placed on its side (long axis) covers  $3\frac{3}{4}$  square inches. So, by calculating the floor area of an incubator in square inches and dividing by  $3\frac{3}{4}$ , the approximate number of eggs is estimated. However, the space required for two eggs should be subtracted to allow for the space taken up by the thermometer.

## **5. How can a person tell a fertile egg from an infertile one? or when an egg was fertilized?**

It is not possible to visually distinguish between fresh, whole fertile and infertile eggs. After they have been incubated 3 days, a small reddish area with blood vessels extending from it will be visible in fertile eggs when they are candled or broken out; infertile eggs will be clear. When broken out, fresh infertile eggs show a smaller, whiter germ spot than fertile ones because cell division has not occurred in the infertile ones but has in the fertile ones, making their germ spots larger and not as pure white. There is no practical way to tell when an egg was fertilized.

# Questions Most Often Asked by Students

## **1. Can two chicks hatch from one egg?**

Yes. It is a rare occurrence. When two chicks hatch from the same egg, the egg usually has two yolks. The development of twin chicks from single-yoked eggs is very infrequent; and when it does occur, the single yolk has two blastoderms (fertilized germs). We have no knowledge of Siamese twin chicks ever being hatched.

## **2. What is a double-yolked egg?**

It is an egg that has two yolks in it. Both yolks were ovulated (released) at or about the same time and enclosed in the same shell. Many eggs with double yolks occur when young adult female chickens first start producing eggs. Their egg forming organs are not adjusted or not yet synchronized, so two yolks are released together. Shortly after egg production starts, the chickens' bodies adjust, and for the most part, they then lay eggs with only one yolk. But, there are some chickens which inherit the characteristic to lay double-yolked eggs and continue to do so throughout their lives. Some chickens may lay eggs with as many as five yolks!

## **3. If a female chicken is hatched with about 4,000 ova and lays only 240 to 250 eggs a year, what happens to the remainder of the ova?**

Depending on the state of health and condition of the chicken, they can continue to exist in the hen's body ready to form a yolk or they can be absorbed by the hen's body.

## **4. Can I hatch the eggs I buy at the store?**

No. The eggs in grocery stores are infertile and will not hatch.

## **5. If a mother hen sits on a fertile egg, will it always hatch? If not, what does she do with it?**

Not all fertile eggs will hatch even when incubated either by a broody hen or in an incubator. Under some conditions they will contain weak or defective embryos. Hatchability is influenced by (1) age of eggs at setting; (2) conditions under which they were held before incubation; (3) parent stock, including its breeding potential, health, and diet; and (4) conditions while the eggs are being incubated. So, the fact that a hen is doing the incubating does not guarantee that a fertile egg will hatch. If an egg or eggs do not hatch, the hen eventually leaves them and the nest. She leaves because the hormone that caused her to go broody is no longer secreted, so she stops setting on the eggs. In a way, it could be said that nature has told her to quit the nest.

**6. How long can the mother hen be off the nest during the day?  
What will happen if she stays off too long?**

A setting hen can be off the nest 15 to 20 minutes or a little longer at one time without harming the embryos, unless the weather is extremely cold. If she remains off too long, the embryos will be chilled too much. Then, some of the chicks may be weakened, and some of the embryos will die and not hatch.

**7. If an embryo dies during incubation, does it feel pain?**

In most cases, no. The embryo just sort of goes to sleep. In the case of severe jolting, extreme heat or cold, or similar causes of death, the embryo might experience some discomfort.

**8. Why does the eye get so big; and why does it grow so fast?**

We do not have the exact answer to this. However, it is possible that both the size of the eye and speed of its growth could be due at least partially to the eye being so very complex and so important. Thus considerable time is needed to completely form and develop it.

**9. Why does the heart grow on the outside of the body at first?**

We do not know why it does so. It is known that the heart helps to circulate blood both in the embryo's circulatory system and in the membranes outside the embryo that carry food to the embryo as it develops.

**10. If you break open the shell, say on the 8th or 9th day, how long can the embryo live?**

The length of time it will live varies with the conditions around it, such as temperature. It is possible to remove the shell at the large end of the egg, replace it with a plastic cap, continue to incubate the egg, and the embryo can then live several days.

**11. Can you open the shell for the chick?**

Yes, but it is not recommended. To do so is frequently painful to the chick. Also, the chick usually is weakened and may die.

**12. Can I find the egg tooth and keep it after it falls off?**

Yes, but it will be very hard to find.

**13. If I find a bird egg, such as a robin's, can I hatch it?**

It is possible, but you should not because a young bird like the robin requires the skilled care of its parents to survive. People cannot provide the same kind of care. The baby bird most likely will die from starvation, cold, or mismanagement.

**14. Can we hold the chicks as soon as they hatch?**

Before the chicks are handled, the hatch should be completed and the chicks should be allowed to dry completely and fluff up.

**15. How can you tell if the chick is male or female?**

Unless the males and females are different colors, you cannot tell them apart without special training. Trained chick sexors can tell the difference by (1) examining the chick's internal organs, or (2) observing the difference in the length of the chick's wing feathers at about 1 day of age.

**16. Can I take the chicks home? if my uncle owns a farm? if I move to a farm?**

No. You should not take the chicks home unless your family or some relatives live on a farm and have the proper equipment and buildings and the knowledge to care for them appropriately.

**17. Are you going to kill the chicks when you take them from the class?**

No. A farmer will take them and care for them.

**18. How long after a chick hatches does it become an adult?**

Those chickens raised for egg production need to develop for about 5 months. Those raised for meat take longer—about 6 months.

**19. How long do chickens live?**

Broilers reach market age in 6 to 8 weeks. On most commercial egg farms, laying hens have completed their usefulness when they are 18 to 20 months old. Records show that when chickens are allowed to live out their lives naturally, many of them will live in the range of 6 to 10 years. Some claims have been made of chickens living as long as 22 years.

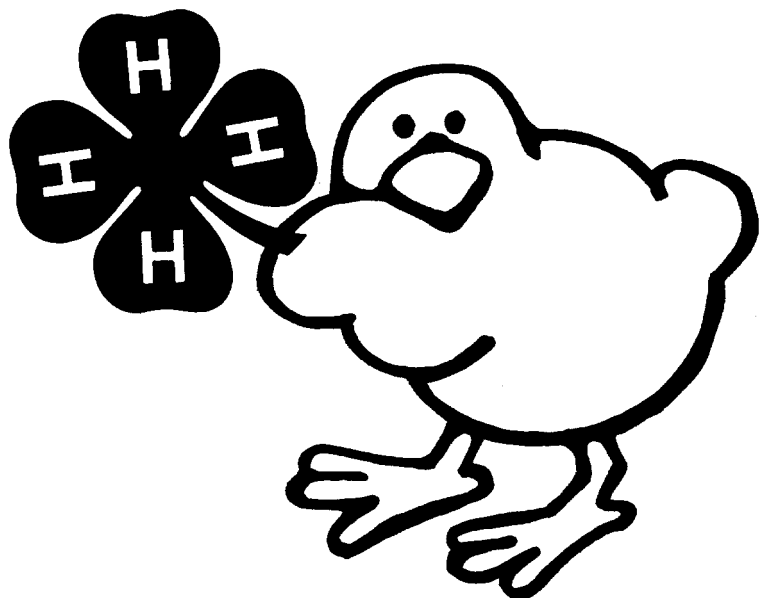

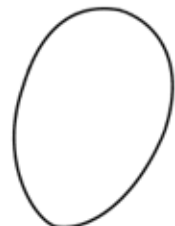
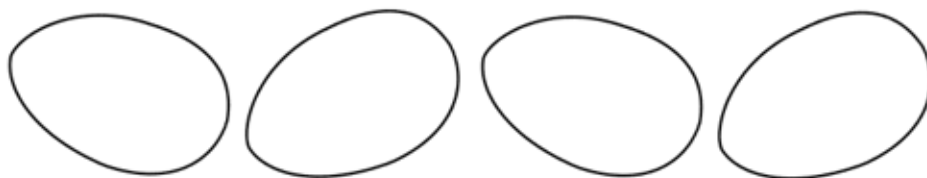
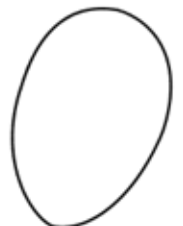
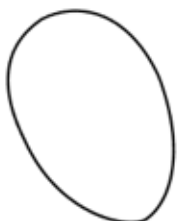
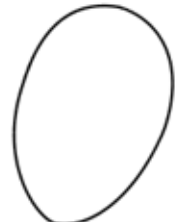
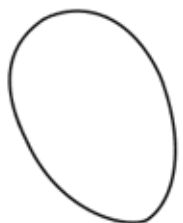
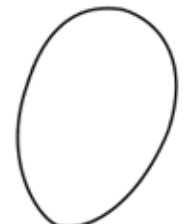
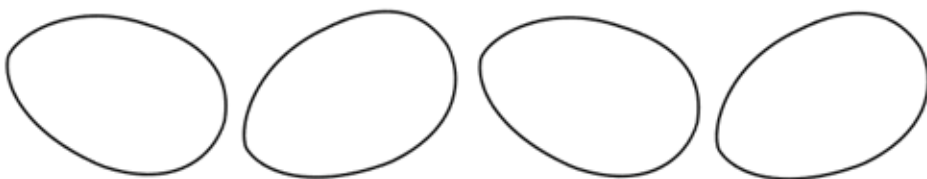

**Awarded To**



**For Eggcellent Work**

**on**



**by**



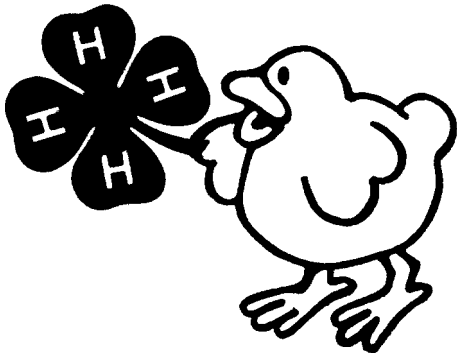

# The Incredible Egg

Name \_\_\_\_\_

Post Test

## True or False (Circle)

- T F 1. Eggs should be hatched at 100°F.
- T F 2. Eggs in an incubator should not be turned every day.
- T F 3. As the baby chick inside the egg grows, it gives off carbon dioxide.
- T F 4. A flashlight will not shine through a normal chicken egg.
- T F 5. A chicken egg takes longer to hatch than a turkey egg.

## Fill in the Blanks or Circle the Correct Answer

6. Name 3 parts of an egg: \_\_\_\_\_  
\_\_\_\_\_  
\_\_\_\_\_

7. How many calories does an average egg contain?

- a. 20
- b. 80
- c. 300
- d. 600

8. Eggs belong in which food group?

- a. Fruits and vegetables
- b. Bread and cereal
- c. Meat
- d. Milk

9. How many days does it take for a chicken egg to hatch?

- a. 12
- b. 21
- c. 32
- d. 40

10. The \_\_\_\_\_ in an incubator is measured using a thermometer.

- a. oxygen
- b. humidity
- c. temperature

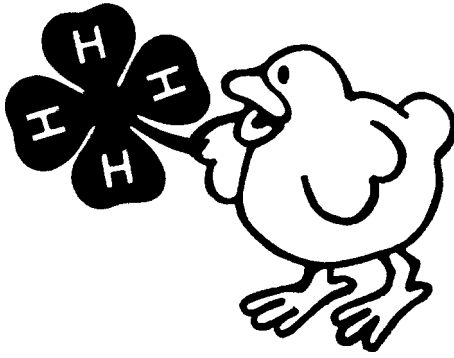

# The Incredible Egg

Name \_\_\_\_\_ ANSWER KEY \_\_\_\_\_  
Post Test

## True or False (Circle)

- F 1. Eggs should be hatched at 100°F.  
T  F 2. Eggs in an incubator should not be turned every day.  
 F 3. As the baby chick inside the egg grows, it gives off carbon dioxide.  
T  F 4. A flashlight will not shine through a normal chicken egg.  
T  F 5. A chicken egg takes longer to hatch than a turkey egg.

## Fill in the Blanks or Circle the Correct Answer

6. Name 3 parts of an egg: SHELL, YOLK, AIR CELL  
ALBUMEN, SHELL MEMBRANE  
CHALAZAE, GERM SPOT
7. How many calories does an average egg contain?  
a. 20  
 b. 80  
c. 300  
d. 600
8. Eggs belong in which food group?  
a. Fruits and vegetables  
b. Bread and cereal  
 c. Meat  
d. Milk
9. How many days does it take for a chicken egg to hatch?  
a. 12  
 b. 21  
c. 32  
d. 40
10. The \_\_\_\_\_ in an incubator is measured using a thermometer.  
a. oxygen  
b. humidity  
 c. temperature

# Eggstra-Special Egg-laying Creatures

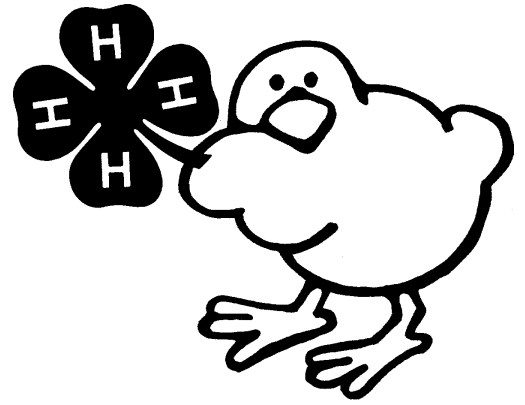

## Across

1. A small American Game Bird—Bobwhite is one variety.
2. One of two egg-laying mammals.
3. Symbolic bird of the United States of America.
4. Waterfowl larger than a duck and smaller than a swan. Duck, Duck, \_\_\_\_\_ .
5. Extinct long tailed reptiles, often large in size.
6. Usually seen swimming in a farm pond. \_\_\_\_\_ , \_\_\_\_\_ , Goose.
7. You can find this bird's eggs in any supermarket.
8. An extinct bird of the Island of Mauritius that is related to the pigeon.

## Down

1. A reptile of land, freshwater, or marine life having a toothless horny beak.  
Some varieties: snapping, box.
2. A slithering reptile. Some produce deadly venom when they bite.
3. A very swift, two toed bird that does not fly. It can weigh as much as 400 pounds, and it is the largest of existing birds.
4. This bird was once used to carry messages from one place to another.
5. The State Bird of Oregon.
6. The most common meat for an American Thanksgiving Dinner.

## Helpful Hints

Meadowlark

Dinosaur

Duck

Ostrich

Platypus

Snake

Goose

Chicken

Dodo

Eagle

Turtle

Pigeon

Quail

Turkey

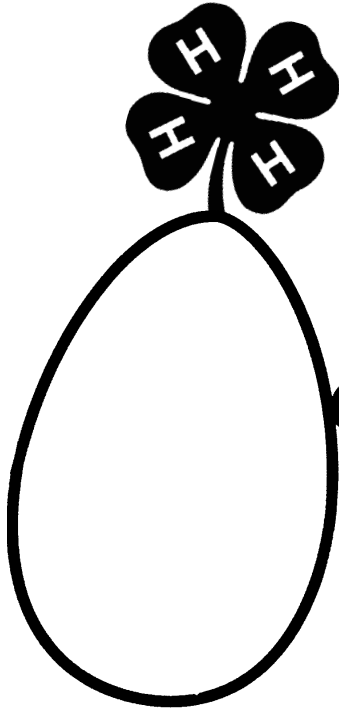

# Eggstra-Special Egg-laying Creatures

Name \_\_\_\_\_

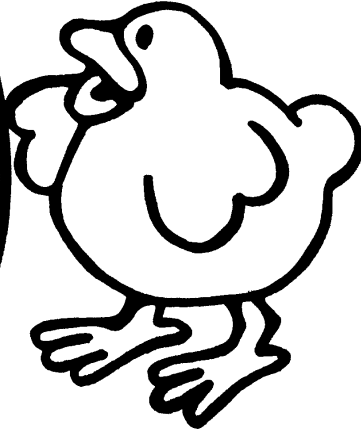

Crossword puzzle grid with the following numbered starting points:

- 1: Down (top right)
- 1: Across (middle right)
- 2: Across (middle left)
- 2: Down (middle left)
- 3: Across (middle right)
- 3: Down (middle right)
- 4: Across (lower middle)
- 4: Down (lower middle)
- 5: Across (lower left)
- 6: Across (lower right)
- 6: Down (lower right)
- 7: Across (bottom middle)
- 8: Across (bottom left)
- 5: Down (far right)



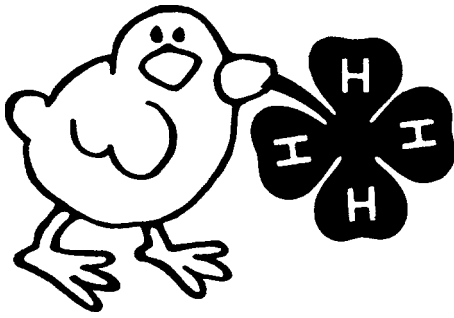

# Scrambled Eggs

Name \_\_\_\_\_

**Unscramble the words below and you'll have the seven parts of an egg.**

1. LHLES \_\_\_\_\_
2. KOLY \_\_\_\_\_
3. LELC RIA \_\_\_\_\_
4. BULANME \_\_\_\_\_
5. BAMRMEEN LLSHEL \_\_\_\_\_
6. ZLAAAACH \_\_\_\_\_
7. TOPS RMEG \_\_\_\_\_

**More Egg-citement. Circle the correct answer.**

8. Eggs are hatched in an \_\_\_\_\_ .
  - a. inqubator
  - b. incubator
  - c. incubater
9. Growing chicks require plenty of \_\_\_\_\_ for a healthy start.
  - a. oxyjen
  - b. oxigen
  - c. oxygen
10. Eggs hatch at either 100.5° \_\_\_\_\_ or 38° \_\_\_\_\_ .
  - a. Fairenheight and Selcious
  - b. Fahrenheit and Celsius
  - c. Fahrenheight and Cellcious
11. Temperature is measured using a \_\_\_\_\_ .
  - a. thermometer
  - b. thermmeter
  - c. thermomater
12. A science that deals with the growth and development of a chick is called \_\_\_\_\_ .
  - a. embriology
  - b. embryolgy
  - c. embryology

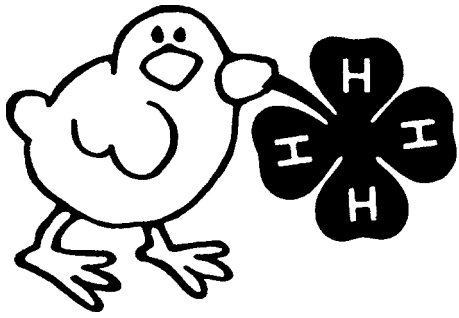

# Scrambled Eggs

Name ANSWER KEY

**Unscramble the words below and you'll have the seven parts of an egg.**

- |                    |                       |
|--------------------|-----------------------|
| 1. LHLES           | <u>SHELL</u>          |
| 2. KOLY            | <u>YOLK</u>           |
| 3. LELC RIA        | <u>AIR CELL</u>       |
| 4. BULANME         | <u>ALBUMEN</u>        |
| 5. BAMRMEEN LLSHEL | <u>SHELL MEMBRANE</u> |
| 6. ZLAAAACH        | <u>CHALAZAE</u>       |
| 7. TOPS RMEG       | <u>GERM SPOT</u>      |

**More Egg-citement. Circle the correct answer.**

8. Eggs are hatched in an \_\_\_\_\_ .  
a. inqubator  
 b. incubator  
c. incubater
9. Growing chicks require plenty of \_\_\_\_\_ for a healthy start.  
a. oxyjen  
b. oxigen  
 c. oxygen
10. Eggs hatch at either 100.5° \_\_\_\_\_ or 38° \_\_\_\_\_ .  
a. Fairenheight and Selcious  
 b. Fahrenheit and Celsius  
c. Fahrenheight and Cellcious
11. Temperature is measured using a \_\_\_\_\_ .  
 a. thermometer  
b. thermmeter  
c. thermomater
12. A science that deals with the growth and development of a chick is called \_\_\_\_\_ .  
a. embriology  
b. embryolgy  
 c. embryology

# For Further Reading

*Eggyclopedia*, American Egg Board, 1460 Renaissance Dr., Park Ridge, IL 60068.  
available at <http://www.aeb.org/LearnMore/Eggyclopedia.htm>

*Eggory*, Georgia Egg Commission, State Farmer's Market, Forest Park, GA 30050.  
available at [http://www.pekinbantams.com/downloads/Eggory\\_book.pdf](http://www.pekinbantams.com/downloads/Eggory_book.pdf)

## **OSU Extension Offices and Branch Experiment Stations**

Please visit: <http://extension.oregonstate.edu/locations.php>

---

Additional publications are available from Oregon State University. They are:

EM 8426-E, *Growing Broilers in Oregon: Facts for the Potential Grower*—(No charge)

PNW 477, *How to Feed Your Laying and Breeding Hens*—50¢

PNW 478, *Hatching Small Numbers of Eggs*—50¢

Many OSU Extension Service publications may be viewed or downloaded from the Web. Visit the online Publications and Videos catalog at <http://extension.oregonstate.edu/catalog>

Copies of our publications and videos also are available from OSU Extension and Experiment Station Communications. For prices and ordering information, visit our online catalog or contact us by fax (541-737-0817), e-mail ([puborders@oregonstate.edu](mailto:puborders@oregonstate.edu)), or phone (541-737-2513).

# THE 4-H PLEDGE

I pledge  
My Head to clearer thinking,  
My Heart to greater loyalty,  
My Hands to larger service, and  
My Health to better living, for  
My Club, My Community, My Country,  
and My World.

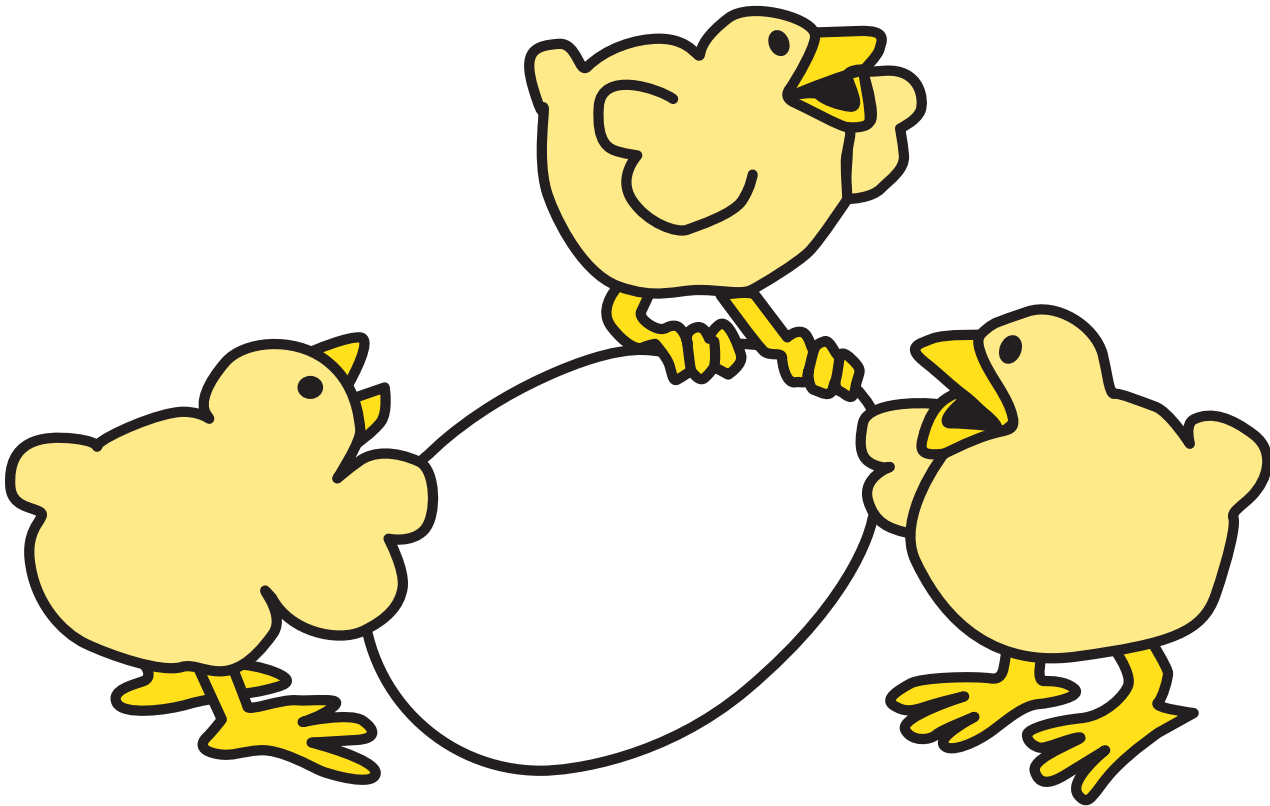

---

This program was funded by private gifts made to the Oregon 4-H Foundation. For more information, please contact:  
The Oregon 4-H Foundation, 119 Ballard Extension Hall, Oregon State University, Corvallis, Oregon 97331-3608,  
(541) 737-2602

---

Adapted with permission from the Ohio Cooperative Extension Service.

---

This publication was produced and distributed in furtherance of the Acts of Congress of May 8 and June 30, 1914. Extension work is a cooperative program of Oregon State University, the U.S. Department of Agriculture, and Oregon counties. Oregon State University Extension Service offers educational programs, activities, and materials—*without discrimination based on race, color, religion, sex, sexual orientation, national origin, age, marital status, disability, or disabled veteran or Vietnam-era veteran status*. Oregon State University Extension Service is an Equal Opportunity Employer.

---