

SPLICING LACE

Cementing

Joining a new piece of lacing to the old is called splicing. Remove the needle from the end of the lacing now being used. Then, with a razor blade or sharp knife, thin the end on a slant about $\frac{3}{4}$ of an inch back. Cut off a new piece of lacing, 4 or 5 feet in length, and thin one end as you did the other piece. Be careful to thin the smooth side of one lacing and the rough side of the other. Thus, when the two ends are glued together, the splice is the same thickness as the lace.

With rubber cement, put a few drops on the thinned end of one piece of lacing and lap the other piece over it. Press together and allow to dry completely. Then continue lacing as before. Be sure that enough cement is used to cover both ends well so that they won't fray.



Substituting

Step 1. When you see you are about out of lacing lay in an extra lace between the two thicknesses of leather above the lacing holes.

Step 2. Lace over this extra lace four or five more holes until out of lace.



Step 3. Insert the short end of the old lace through the first thickness of leather or about half way and bring up from between the two thicknesses. Bring new lace through hole of the second thickness or the other half.



Step 4. Lay short end of old lace back between the two thicknesses and above lacing holes, and continue lacing with new lace.

When properly done, it is almost impossible to tell where a new lace was added and is much more permanent a method.

ATTACHING SNAP BUTTONS

Materials Needed

Snap-button outfit
Revolving punch



cap



eyelet

How to Do

1. There are 4 different parts to a snap button-- the cap and eyelet form one unit, and the spring and post form the other.
2. Locate and punch the proper-sized hole for the eyelet. Use a piece of scrap leather to make a test hole to check the size.
3. Insert the eyelet through from the under side of the leather. Lay the eyelet on the anvil of the snap-attaching set with the flesh side of the leather down. Place the cap over the eyelet and the concave part of the hammer of the snap-attaching set on top of the cap. Strike the hammer sharply with a mallet. This will fasten the parts firmly together. Too much force will cut the leather around the eyelet.
4. Locate the hole for the post by aligning all parts and then pressing the cap firmly in position where it is to snap on to the spring. The eyelet will leave an impression, thus locating the position for the spring and post. Punch a No. 1 hole.
5. Insert the post through from the under side of the leather. Lay the post on the anvil and place the spring over the post. The hollow part of the hammer is placed over the spring. Strike the hammer sharply with the mallet. Test the snap button. If it is too loose, lightly tap the spring. If the cap will not close over the spring, loosen the spring by lightly compressing it with a pair of pliers.



spring



post

How to Set Buttons and Attach Buckle on Belt

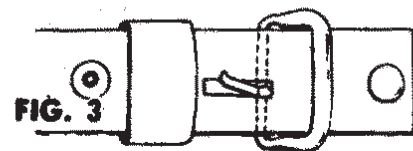
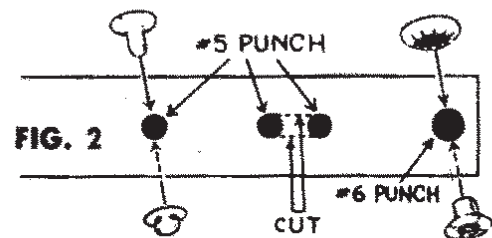

Advanced Leathercraft

Many leather tools were designed for a special purpose or to make a special job easier. If you plan to do a lot of leather work it will pay to get some of these special tools in addition to those you needed for Unit I. Some which are handy to have are:

Skiving Knife (For skiving leather)



Beveled Edge Skiving Knife (Used mostly to skive or thin edges of heavier weights of leather.)

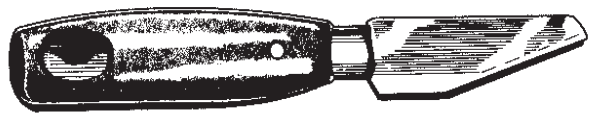

Dye Brush

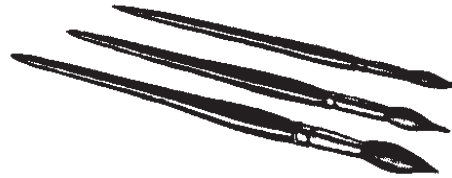

Bag or Oblong Punch (Easily punches buckle slots, bag slots, etc. in heaviest leather.)

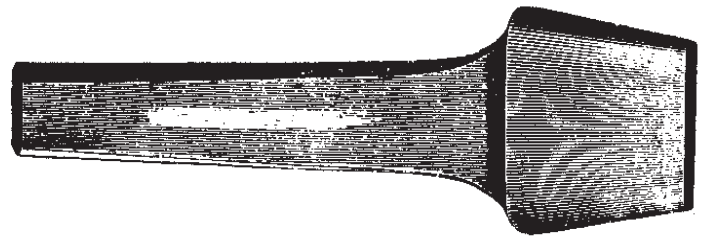

Round Drive Punch (Sizes 0 to 12)

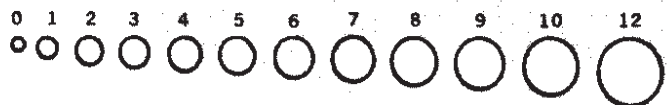

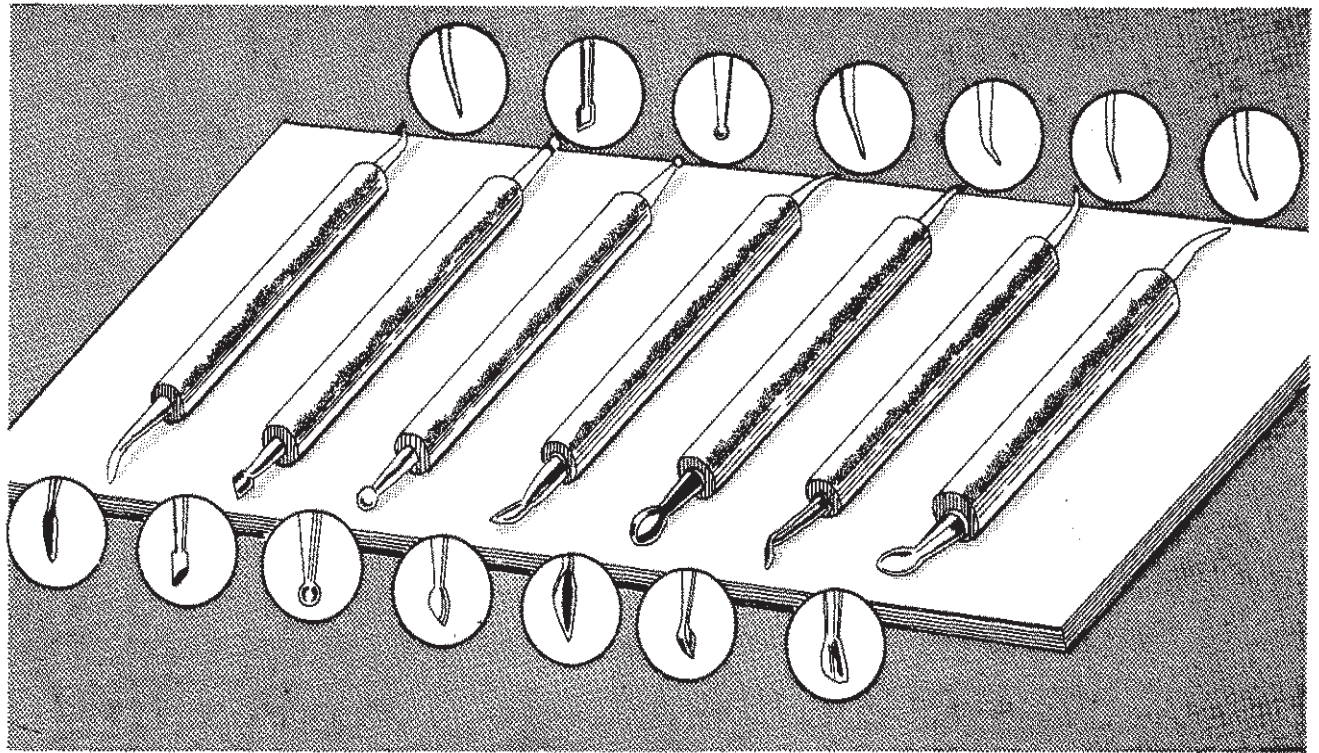

Modeler

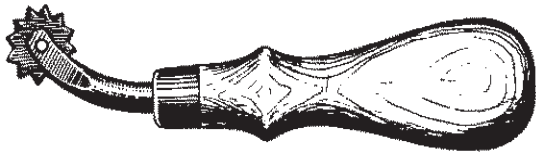

Spacer (Sizes 5-6-7)

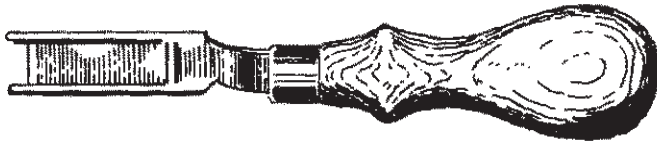

French Edge Skiving Tool.
For both left and right handed persons. Tool gouges, channels, skives and countersinks rivets.

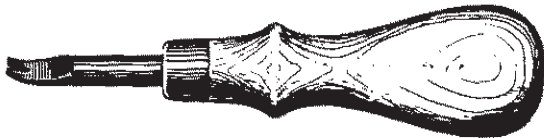

Edger (Sizes 1-2-3-4-5)



Bone Folder (Smooth finished white bone folder for pasting and folding. Six inches long.)

Creaser (Sizes 1-2-3-4-5)



Circle Edge Slicker (Used for polishing unlaced edges.)

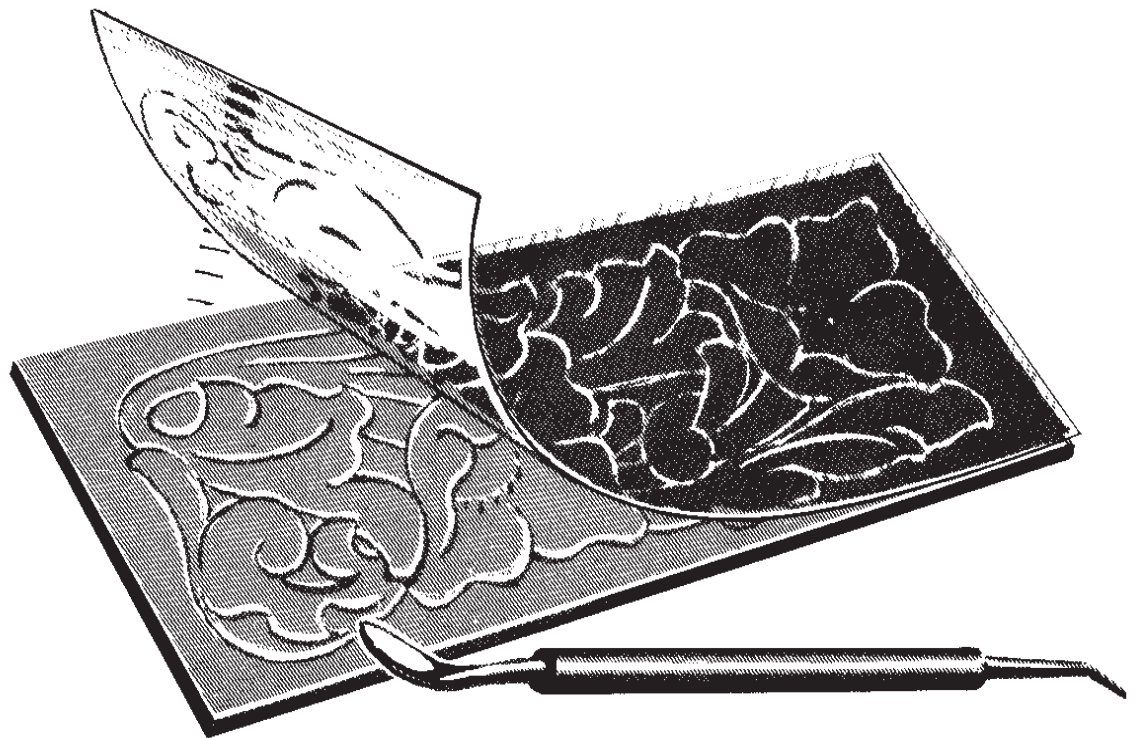
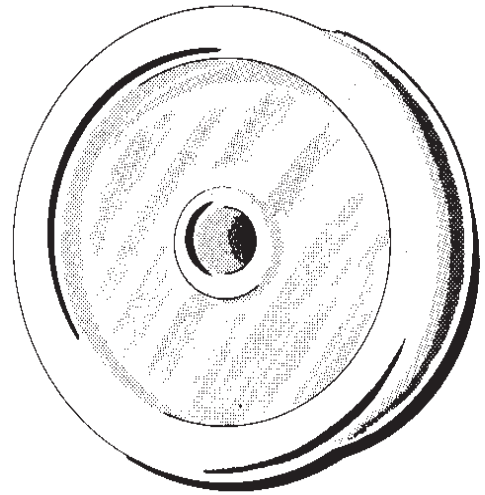

"**Craftaids**" are plastic patterns and may be obtained for many items. They furnish a quick way of transferring designs to the leather.

Ways to Decorate Leather

(Other Than Carving or Stamping)

Outline Tooling

Remove the paper design after all lines have been traced, and moisten the leather again if necessary. If the leather is too moist, water will ooze up the back of the modeler as you tool. If the leather is too dry, the modeler will tend to scratch or break through the outer surface of the leather.

Place the leather on a smooth, flat surface, such as marble, and go over the outline lightly until you have retraced the design. Hold the modeler as you would a pencil. Go over the design several times, increasing the pressure each time, until the outline of the design is very clear and the lines are depressed uniformly.

Use a straight edge to tool straight lines.

Flat Modeling

This method of decorating leather is more advanced than outline tooling and will take more time and patience. The design will be just the opposite of outline tooling for the background is depressed, making the design stand out in bold relief. Take care not to mar or scratch the softened leather with fingernails, tools, or other objects.

Remove the paper design and moisten the leather a second time if necessary. Go over the design on the leather with the modeler as in outline tooling.

Depress the background around the design by using the broad end of the modeler, holding it parallel to the surface of the leather. Use considerable pressure to smooth out the background, but be careful so you don't rough up the leather. This may be smoothed by rubbing the leather with the grain.



The deerfoot modeler may be used for putting down the background by holding it in an almost vertical position. Use a firm, even pressure on the deerfoot, pressing down the background around the design. The edges of the design may be softened by taking the broad end of the modeler and smoothing them.

Stippling

Stippling the backgrounds of designs, accentuates the design and makes them more beautiful.

Moisten the leather as in any other form of tooling and place it finished side up, on a piece of marble.

Use the small end of the modeler to do fine stippling. Take care not to break through the outer surface of the leather.

A ball-point modeler may be used to stipple. Hold the ball point in a vertical position and enrich the background with a tapping motion. Better results may be obtained on some leathers by applying pressure to the tool and turning it at the same time. This will make a clear, round impression on the leather.

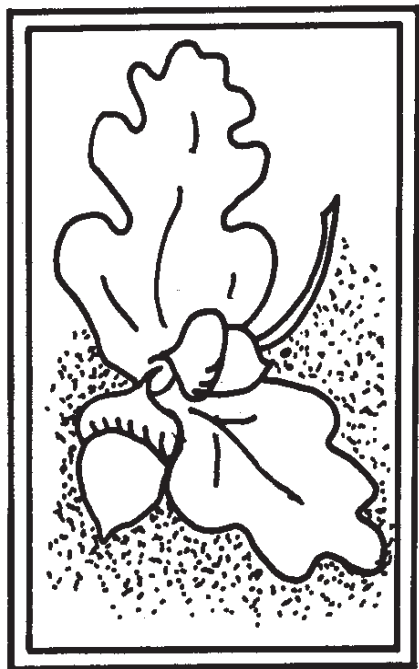

EMBOSSING

Embossing is raising the design, or part of it, above the surface of the leather by working it out from the flesh side. A 3/4 oz. cowhide lends itself well to embossing. Heavier weights, though, can be used for large projects.

Two general methods of embossing are used. The "plug" method, in which a plug of leather, carved and sculptured to the contours of the design, is glued into the cavity; and the "packing" method, when materials such as cotton or leather shavings mixed with rubber are glued into the embossed area. Both methods employ the same basic steps.

Step 1. Transfer design to grain side of leather, and cut all solid lines with the swivel knife. Bevel all around the outline of the area to be embossed. The tooling will then show through on the reverse side of the leather

Step 2. Turn the dampened leather with the grain side down; hold in palm of hand and with a modeler, work the leather into a cavity which will accommodate the plug or packing materials.

Figure 1. As the leather is worked down with the modeler, keep in mind the contours of the figure, and work the portions of the cavity to the desired depth of these contours.



FIG. 1.

Step 3. If the plug method is used, the plug must be sculptured to add greater depth to the carving. The plug is cut smaller than the outline of the design, see Figure 2. The plug is cut out and then shaped to the design's contour; Figure 3. When the plug has been shaped sufficiently, it is glued into the cavity.

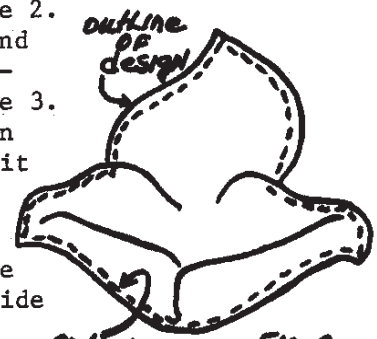

FIG. 2.

Step 4. Turn the leather over, right side up, and re-bevel the outlines of the design; Figure 4. This procedure forces the plug into position.

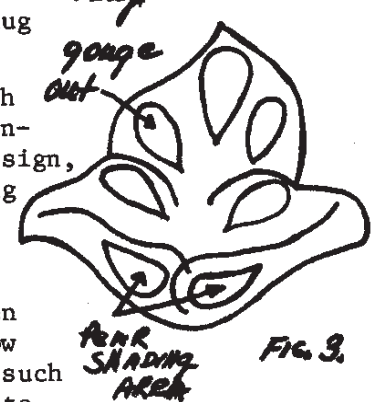

FIG. 3.

Now proceed with the carving of all inside lines of the design, and complete beveling and stamping in the regular way. Work over the plug; the fact that it has been sculptured will allow the stamping tools, such as the pear shader, to sink into the plug and give greater depth to the design.

All steps for embossing, using a packing material instead of a plug, are the same for shaping the cavity.

The "packing" method lends itself well to small areas. Once the cavity is formed, the packing material is mixed with rubber cement and

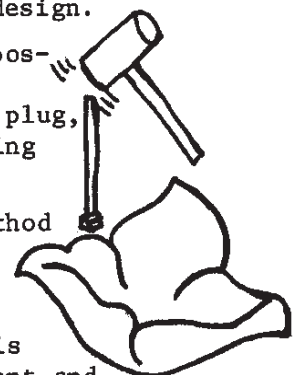

FIG. 4.

then packed firmly into the cavity. Fine leather skivings make excellent packing materials.

Before the packing material sets firmly, turn the leather right side up and follow Step 4. Since the packing is still soft, it will yield and be forced into the depressed areas, and out of the areas where it is not supposed to be.

If the cavity has been filled too much, the excess will be forced over the outline of the design area. The excess is then cleaned off, or skived off to make the plugged area level with the outline of the design.

A packed cavity is softer to work on than a plug, and care must be taken not to force too much of the packing out of the raised areas.

Once the plug, whether a sculptured plug, or of packing material, has been worked to the desired dimensions, glue

a thin piece of leather, such as skiver, to the flesh side of the project to help keep the plug in place.

Sometimes it is not possible to cut a plug as thick as you would like the embossed portion to be. When this situation arises, the embossed area is either plugged or filled, as described above, and then layers of leather are glued on top of the plugged area until the whole depressed area is filled level to the surface of the flesh side.

In order to maintain the proper perspective in a picture, the figures in the foreground should be higher embossed than those in the distance.

Some of the tools that are needed for cutting and shaping plugs are; a skiving knife, a cutting knife, such as a Xacto knife, a gouge, edge bevelers, and if available, wood carving chisels work very well for removing portions of the plug.



How to Filigree

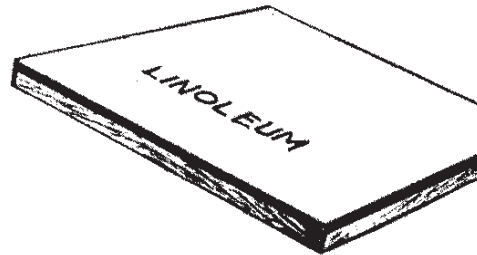

TIP
GLUE A PIECE OF HEAVY LINOLEUM TO A SMOOTH BOARD. THIS MAKES A GOOD CUTTING BLOCK FOR FILIGREE WORK, CUTTING STENCILS, PUNCHING HOLES, ETC.

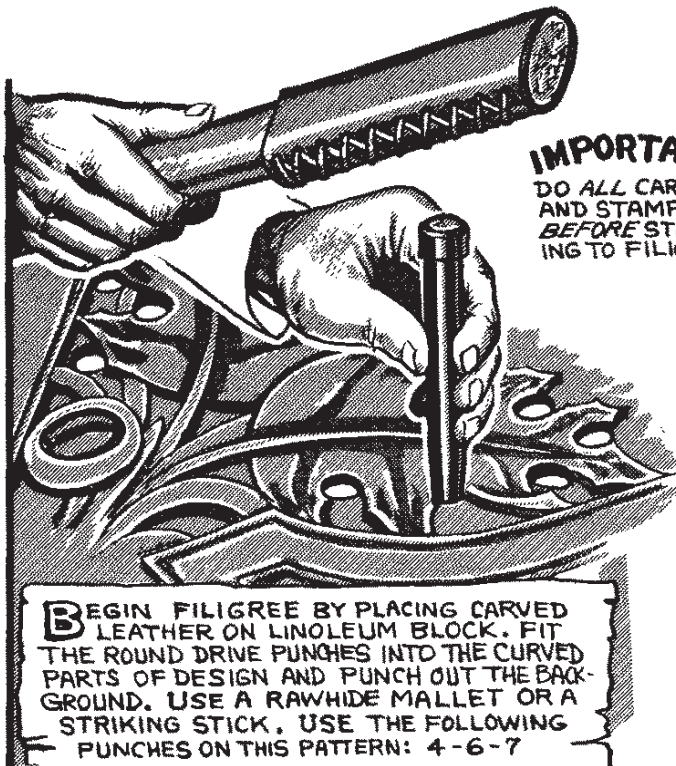

IMPORTANT!
DO ALL CARVING AND STAMPING BEFORE STARTING TO FILIGREE.

DON'T DO THIS →
NEVER CUT THRU A STEM. REMEMBER... ONLY THE BACKGROUND IS REMOVED.

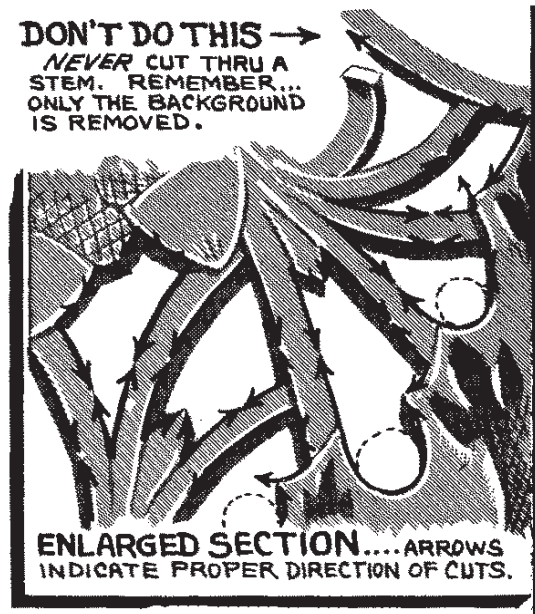

ENLARGED SECTION....ARROWS INDICATE PROPER DIRECTION OF CUTS.

BEGIN FILIGREE BY PLACING CARVED LEATHER ON LINOLEUM BLOCK. FIT THE ROUND DRIVE PUNCHES INTO THE CURVED PARTS OF DESIGN AND PUNCH OUT THE BACKGROUND. USE A RAWHIDE Mallet OR A STRIKING STICK. USE THE FOLLOWING PUNCHES ON THIS PATTERN: 4-6-7

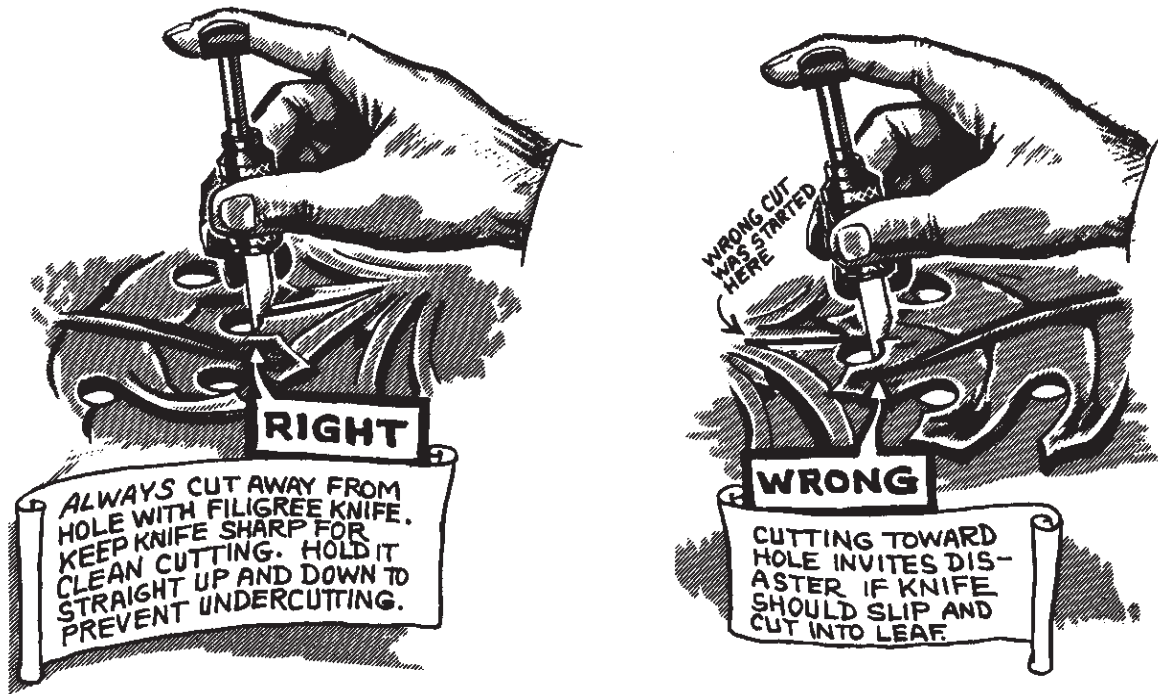

After filigreeing, apply leather dressing to carved panels. Use a small brush to thoroughly cover edges of filigreed areas. Colored leather--gold kid,

silver, red, green, white, or any one of a large variety now available-- is sometimes used between the lining and the filigreed panels.

Here is a photograph of an 8 inch mat of filigreed leather. It can be used to set potted plants on or for any number of other purposes. When well coated with a leather dressing it is quite waterproof.

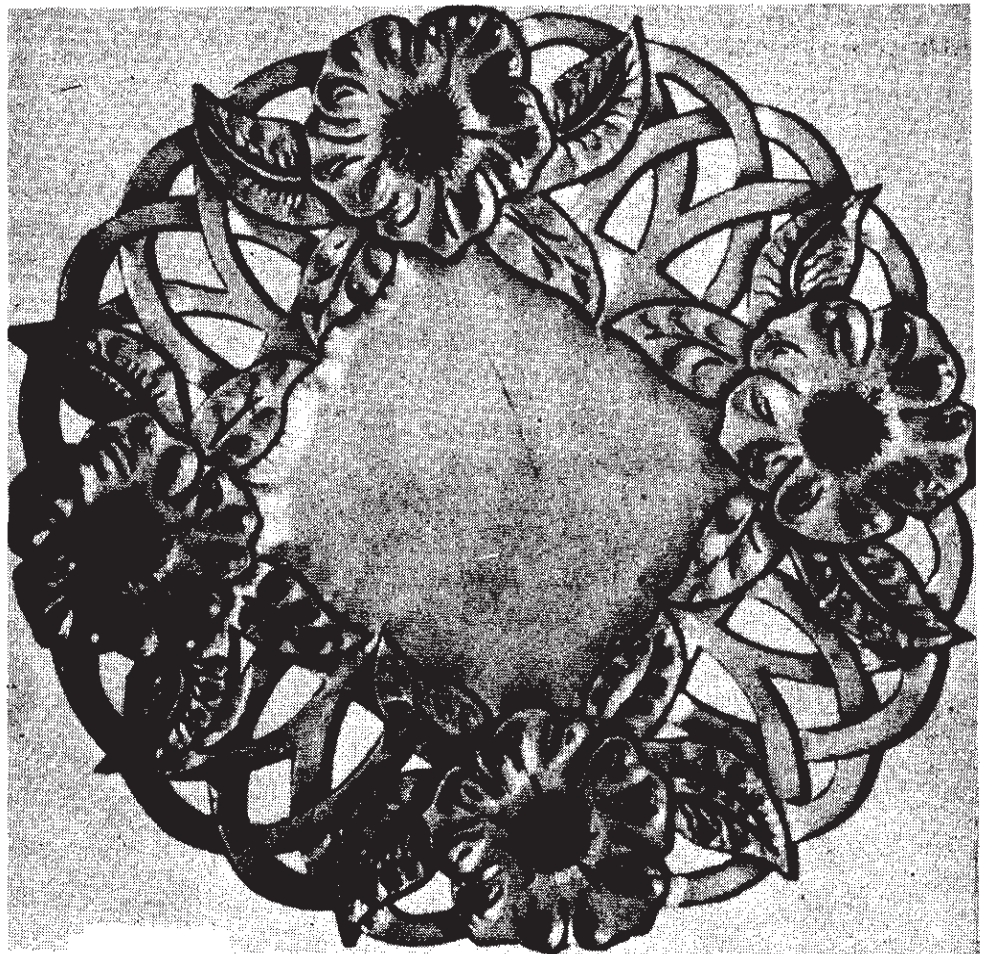

Hand & Machine Stitching

Machine Stitching

The ordinary sewing machine found in the home can sew leather. Machine sewing is used to fasten zippers to leather, to sew gussets, purses, bill-fold pockets, etc. The leather cannot be too thick or you will encounter trouble. A used sewing machine for heavy work can often be bought at a sewing machine shop.

1. Place a straight No. 19 needle in the needle clamp and tighten. Be sure the flat side of the needle faces the right way, and that the thread will lie in the long groove of the needle during the sewing. Use an E shoe-twist machine-silk or linen thread of about the same weight. Silk thread will work much better on the machine, since it is not as stiff as linen thread, but by dropping the needle about one-half the thickness of a dime, better results will be obtained with linen thread.
2. Fill the bobbin and replace it. Then thread the machine correctly and check for the proper tension.
3. Set the stitch regulating lever or screw so that the machine will sew nine stitches per inch for zippers in notebooks or for sewing where the leather is very thick. Too many stitches per inch will cut the leather.
4. Pieces of leather to be sewed should first be cemented together. This will keep the leather from slipping and will keep suedes from stretching.
5. Start sewing by laying both ends of the thread back under the pressure foot. Place the edge of the leather just far enough under the pressure foot so that the first stitch may be taken. Lower the pressure foot and begin sewing.
6. To finish the sewing, stop the machine before reaching the end of the seam. Raise the pressure foot and remove the leather by pulling it straight back away from you. Leave enough thread to tie the ends and to prevent the thread from pulling through the needle.

Hand Stitching

Since a sewing machine isn't always available, it is well to know how to hand stitch. Hand stitching is often better for some leather projects than machine stitching--especially for those with hard-to-get-at corners. Practice on scrap leather.

1. Locate and draw a very light line with a pencil for the row of stitching holes. On small and light weight work, this line should be 1/16 inch in from the edge of the work. If the work is heavier and larger, this line may vary up to 1/8 inch from the edge.

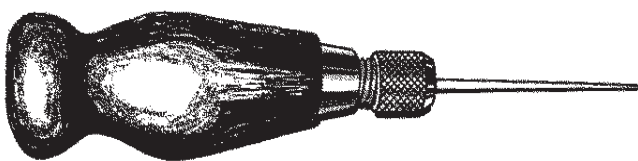

Awl Haft and Blade for
prepunishing stitching holes.

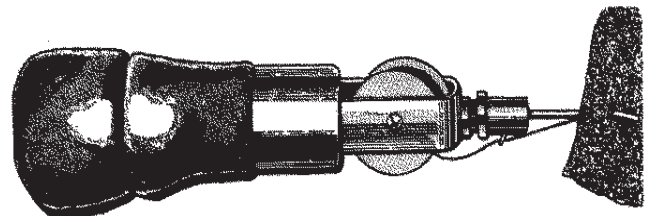

Lock Stitch Awl for hand sewing.

2. Determine how many stitches per inch are to be made. For light work there should be 8 to 10 stitches per inch, for heavy work 5 to 6 stitches per inch. Place on a clean, smooth, soft board. Use the correct space marker to cut the holes through light weight leather. A stitching punch may be used on heavier leather by holding it in a vertical position and tapping it lightly with a wooden mallet, just cutting through the leather.

3. For stitching small projects made from light weight leather, use a common sewing needle, size 5, and buttonhole twist silk. Use a larger needle and linen thread for larger projects made from heavier leather. Linen thread should be waxed before it is used by pulling it through a piece of bee's wax.

4. Two needles and two sets of string gives a tighter stitch.



Skiving

Skiving will reduce the thickness of the leather in areas where several pieces will join or where the leather will be doubled over and cemented to make a facing. This paring down of the thickness is done on the flesh side of the leather only. A special safety skiver, head knife, or beveled edge knife is

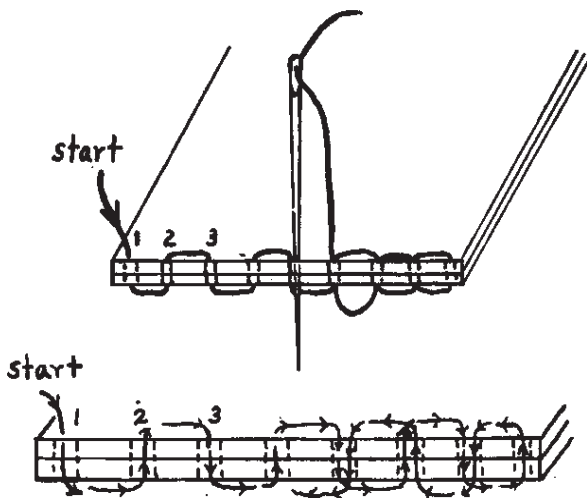

Running Stitch

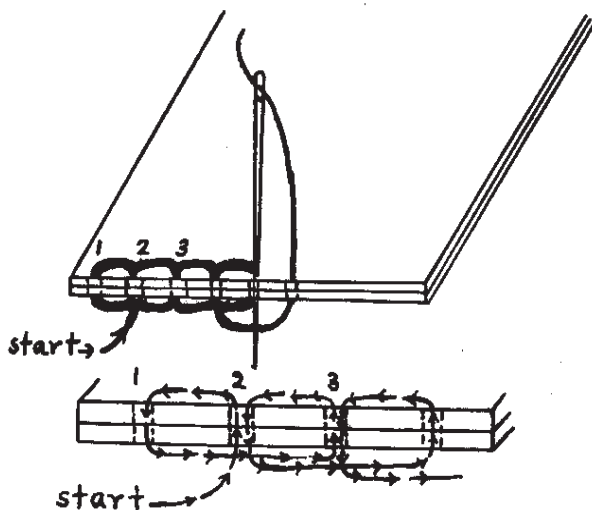

Back Stitch

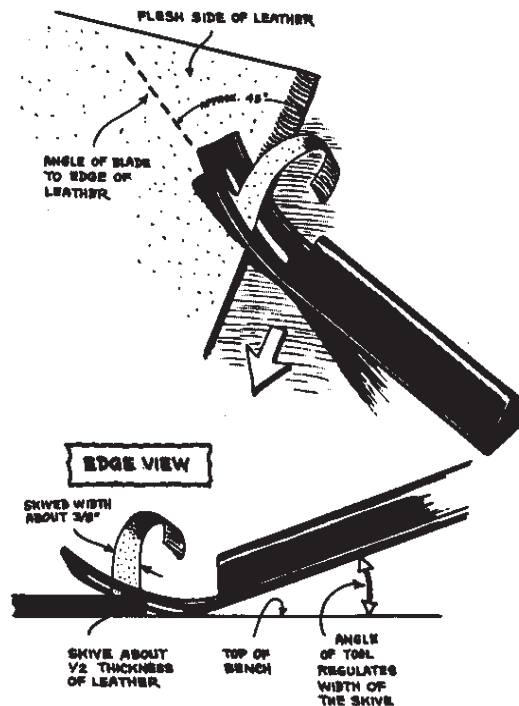

used. Places where skiving would be helpful include belt ends which must pass through a buckle or the main part of a handbag where the gusset is to be joined.

Border Lines

To cut border lines in belts, straps, or handles, use a swivel knife and straight edge. Cut a line about 1/8 inch from each side. You can use a creaser or cutter designed just for this purpose.



Edging Belts, Etc.

For a professional appearance use an edger to round off edges that are not to be laced. This tool cuts only at the proper angle and is safe to use.

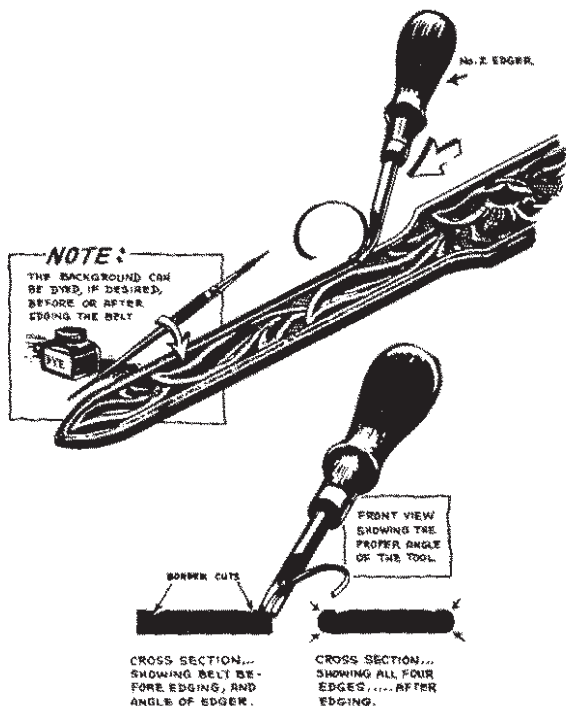

Burnishing the Edges

Burnishing means to smooth the fibers along the edges of a project, giving them a rich brown color. Use this technique on belts, straps, and other edges not covered with lacing. Moisten

a sponge with water and wet the edges to be burnished. Hold the project securely (on strap-like projects, lay them on a table or bench with the edge sticking out), and rub a circle edge slicker rapidly and firmly over the edge. If the project has edges which are to be dyed, apply the dye before you burnish to allow greater penetration of the dye into the leather.

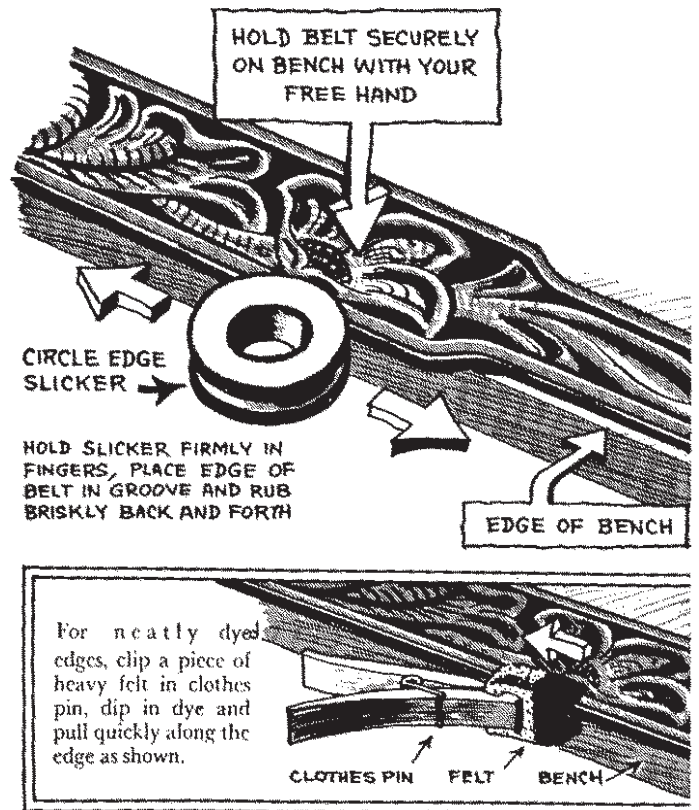

Folds

Marking the Fold Line

Be sure the leather has not stretched out of shape. Using a straight edge, make a line for the fold with a pencil. Make sure that the fold line is in the right place.

Gouging the Fold

Gouging removes some of the leather for easier folding. Normal gouging depth is about 1/2 the thickness of the leather. Lay the leather grain side down and gouge only the flesh side. Using the

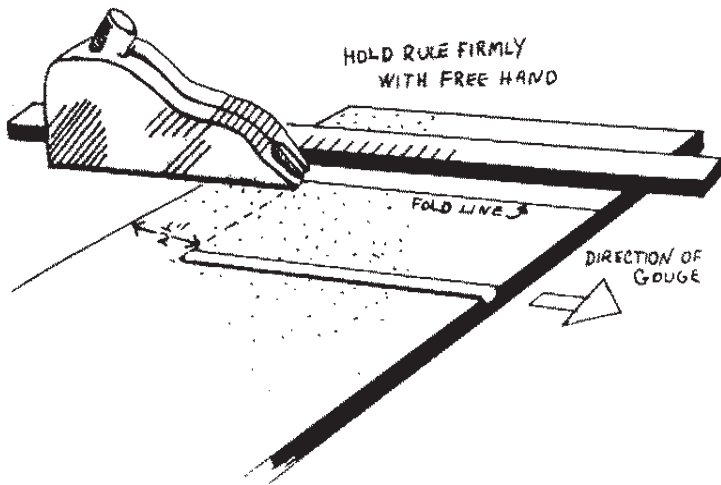

adjustable gouge, begin gouging about 1/2 inch from the end of the leather. Use a straight edge as a guide to hold the gouge steady along the marked line. Gouge to the end of the leather, turn the leather around and gouge the 1/2 inch of leather still at the other end. If you moisten the leather along the marked line, it may be easier to gouge.

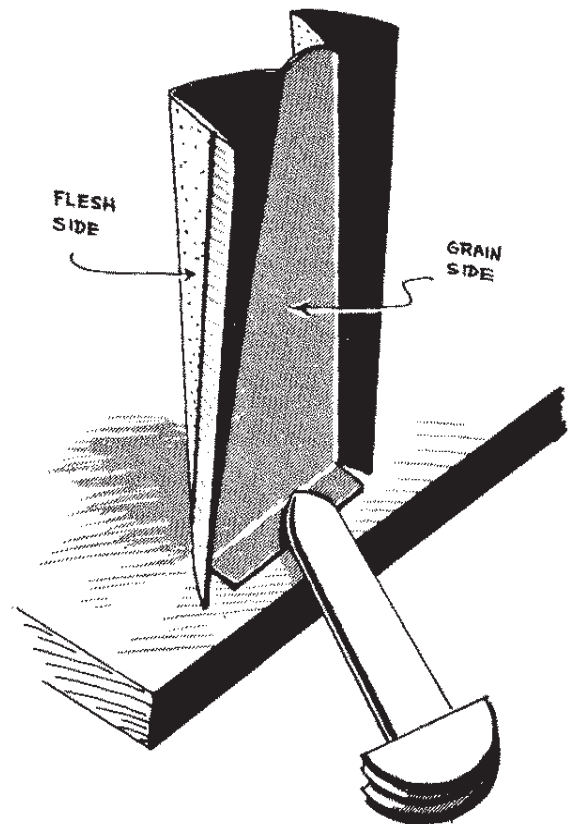

Folding Gussets, etc.

Dampen all the gouged areas with a sponge. Lay the project on a hard surface and use the bone folder to crease

the leather along the gouged marks. Where one end of the project turns out (as in a purse gusset), turn it up on the bench and use the point of the bone folder to make a sharp crease. Avoid rubbing too hard with the folder, as this will be on the grain side and will burnish the leather.

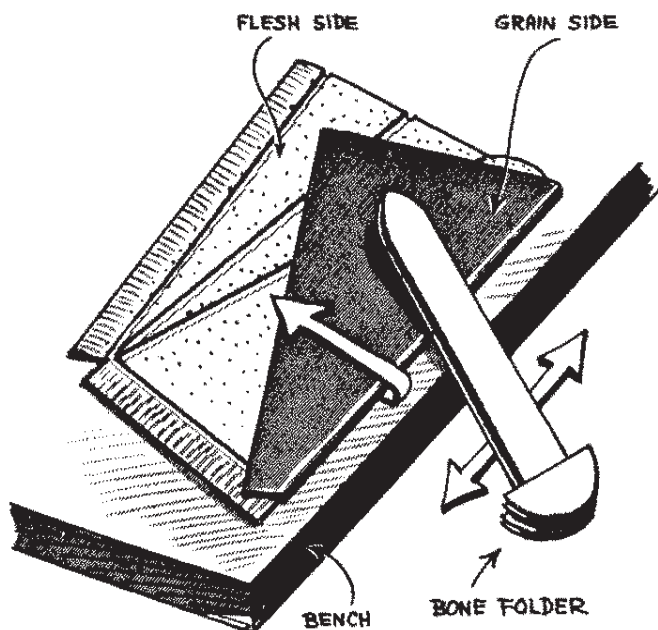

Cementing Stiffeners in Place

After all gouging and skiving have been done, allow the leather to dry. Carefully apply a thin layer of rubber cement over the flesh side of the leather where the stiffener is to be laid, and on one side of the stiffener. Begin at the bottom of the stiffener and carefully place the pieces together. Take care to avoid getting any cement into gouges or holes.

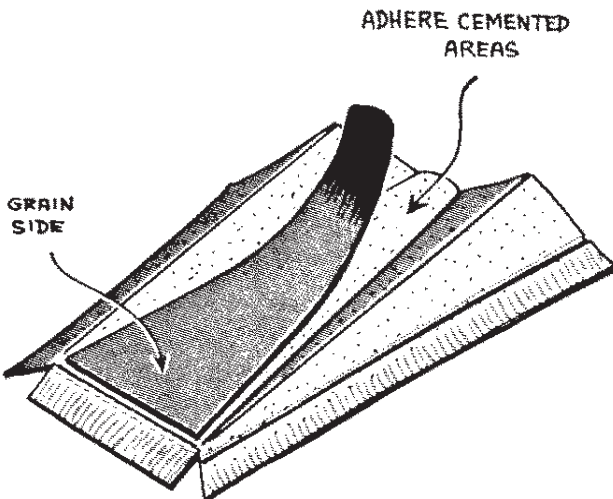
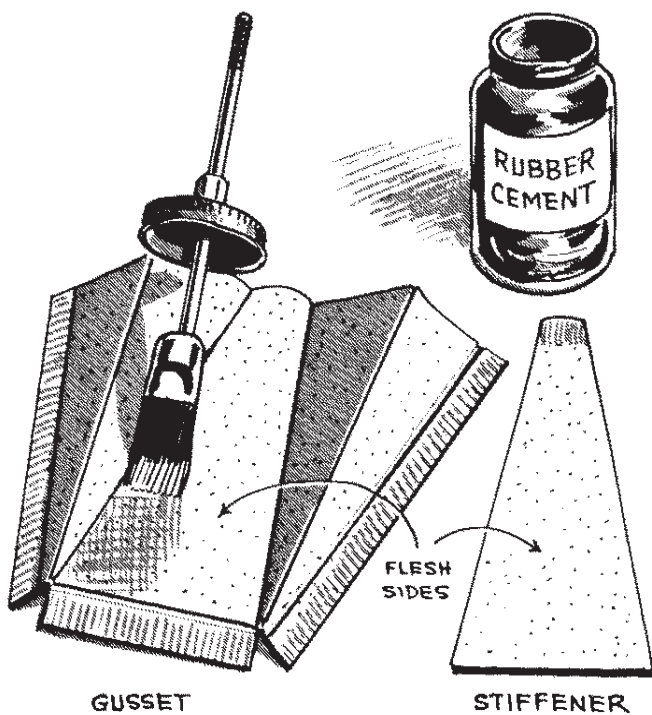

Installing Hardware

Installing Bag Clasps

Be sure to mark the position for the clasp on the leather, as indicated on the pattern. With the prongs of the clasp straight, position it over the mark and press firmly enough to make indentations from the prongs. Remove the clasp and use a thonging chisel to punch the holes for the prongs. Place the prongs through the holes and fit the back plate over the prongs. Bend the prongs over the back plate. Install strap hangers the same way, except that no back plates are used.

Installing a Bag Clasp Eyelet

Fold the flap over and use a pencil to mark the center of the clasp. Open flap and lay it flat. Position the eyelet on the leather and draw around the inside with a pencil or stylus. Cut out this area

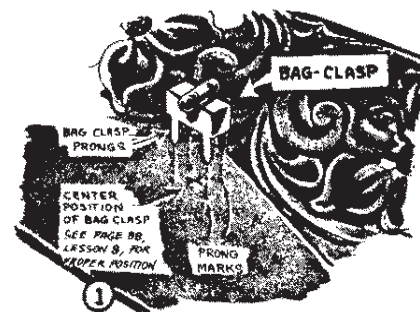

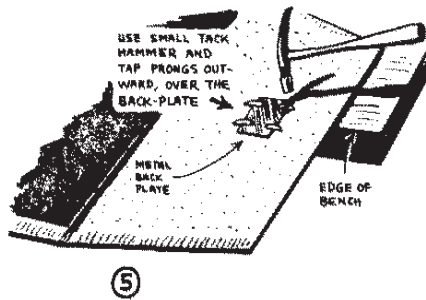
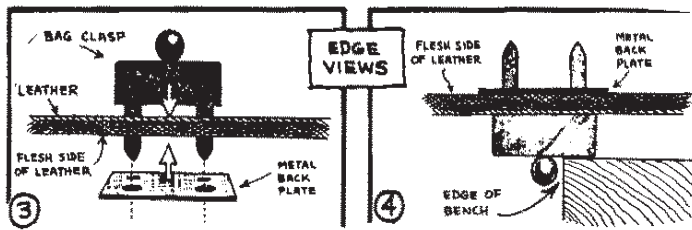

with a sharp knife. Place the eye into slot from carved side; turn the lining side up and slip back plate into position. Fold prongs over into depressions and tap with mallet.

Joining Pieces

When two leather pieces are to be joined, use a knife to scuff (rough-up)

the edges of the leather. This is a necessity on finished or dyed leathers where cement will not adhere well. Scuff an area about 1/4 inch from the edges. Apply two coats of cement to each edge to be joined. Let them dry before joining them. Carefully align the pieces and press together. Sometimes a mallet is helpful to tap down the edges.

Attaching Flaps and Extra Pieces with Rapid Rivets

Punch the rivet holes in any flat piece before that piece is laced to the main body of the project. Position a rivet cap on the outside of the project with the raised portion in the hole. Lay the project down on a hard surface, such as metal, and place the stud of the rivet down through hole into cap. Strike the stud of the rivet hard with mallet to firmly set it.

Knobby rivets can be used on the corners of handbags and bowling bags, etc., to prevent scuffing and marring the bottom of the bag and to help prevent lacing from wearing through at the bottom. Check the length of the rivet post and if it is too long, cut it off before installing.

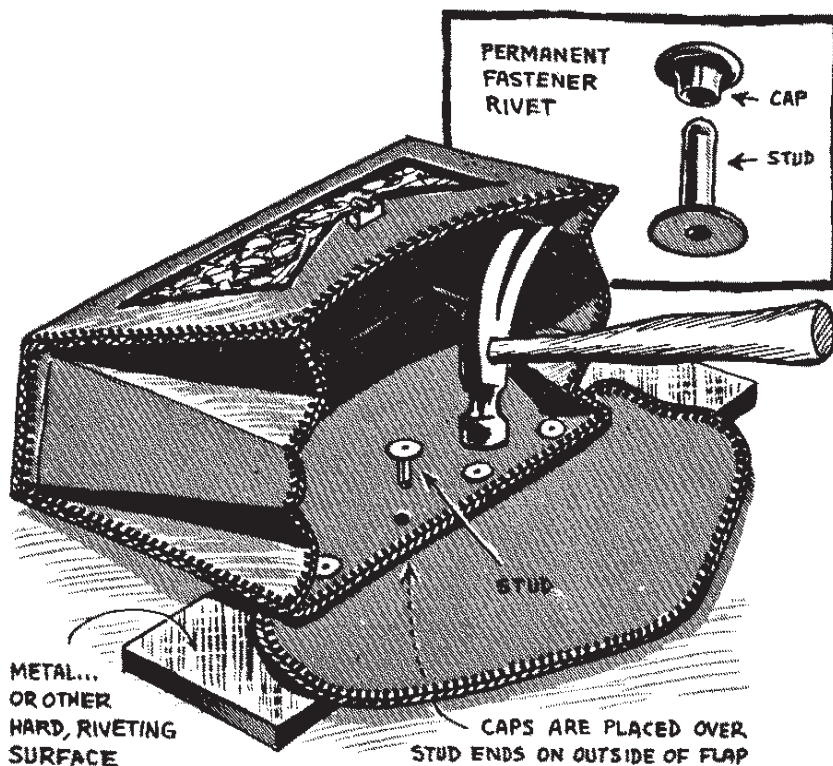

Cementing the Lining

Apply cement to the skived edge of an article.

Smooth out any wrinkles in the lining by rubbing toward the edge with a bone folder.

The lining is shown as attached to a folded article such as the flap of a bag. Cement the flat surfaces together at the edges, then place over a block or table edge with the lining against the edge at the point at which the fold is to be made. Apply cement along the fold and out to edges of flap. Then press carefully together, working toward the outer margin of the flap, smoothing out any wrinkles in the lining. Additional cement may be necessary if it becomes too dry to adhere.

A form is used here in the same manner. This may be shaped from a block of wood for small articles, or made of sheet metal tacked to end blocks of the proper size for larger purse flaps.

The same thing may be accomplished without a form as indicated in this picture. Here the lining is kept smooth and all bulging and wrinkles worked out between the thumb and fingers as the fold is gradually made. This method is satisfactory for small articles.

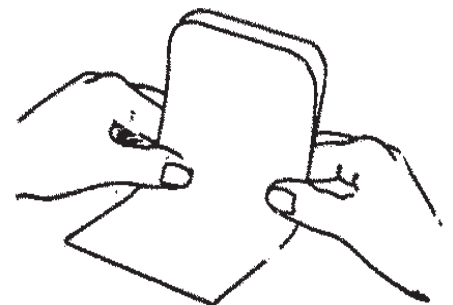
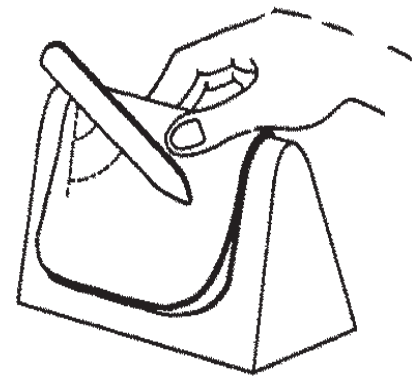
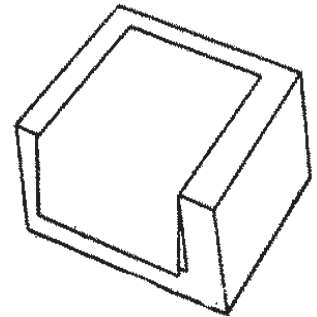
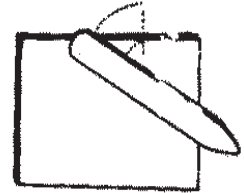
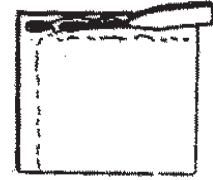

These pictures show the procedure in lining a gusset. Note that the top of the outside piece is skived back farther from the edge than the other margins. Picture "b" shows the shape of the lining. It is shorter than the outside piece and the depth of the skived edge is the same on all margins. Apply the cement to the edges and along the line of the fold; then place the lining in position as shown in sketch "c". Fold the whole gusset as in

sketch "d". Press the edges firmly and smoothly together while holding in the folded position. Fold the top edge of the outer leather, which extends beyond the lining, over the lining and cement it down. The gusset is now ready to be inserted in the proper position in the bag, as shown in sketch "f". Cement the edges of the gusset to the edges of the outside of the purse to hold them in position while the bag is punched and laced.

