

The Wonderful World of Wood

Unit II Member Manual

National 4-H Wood Science Series

4-H 4422
Reprinted September 2006

Oregon State | Extension
UNIVERSITY | Service



Acknowledgment

Reprinted for use in Oregon.

This educational material has been prepared for 4-H use by the National 4-H Wood Science Committee, composed of representatives of Extension Service, U.S. Department of Agriculture, and the Cooperative Extension Service of the State Land-Grant Universities. Special thanks are extended to the Weyerhaeuser Company Foundation for financial and technical assistance. This material is published by the National 4-H Council, 7100 Connecticut Avenue, Chevy Chase, MD 20815.

National 4-H Council is a not-for-profit educational organization that utilizes private resources to help expand and strengthen the 4-H program.

4-H is the youth education program of the Cooperative Extension Service of the State Land-Grant Universities and the U.S. Department of Agriculture.

Programs and educational materials of National 4-H Council are available to all persons regardless of race, color, sex, age, religion, national origin, or handicap. Council is an equal opportunity employer.



Contents

| | |
|--|----|
| Introduction | 3 |
| Opportunities for Learning and Doing | 4 |
| Work Safely | 5 |
| Trees, Forests, and Forest Products | 6 |
| Learning to Use Wood | 8 |
| Plywood | 10 |
| How to Use the Grid System | 11 |
| Woodworking Tools | 12 |
| Steel Tape and Folding Rule | 12 |
| Scratch Awl | 12 |
| Combination Square | 13 |
| Pencil Compass | 13 |
| Hand Saws | 14 |
| Power Saws | 15 |
| Tools for Boring Holes in Wood | 15 |
| Hand Drill | 15 |
| Wood Screws | 17 |
| Oscillating Sander | 18 |
| Woodworking Plans | 19 |
| Glossary | 30 |

Note to Parents and Home Helpers

You as parents and home helpers are the key to your children completing Wood Science Unit II, *The Wonderful World of Wood*. Even though 4-H leaders help guide and direct your children's work, as parents you should be involved in the planning stages, and also work with your children throughout this project.

Get involved! Make woodworking a family activity. Wood science provides one of the best "learn by doing" opportunities in 4-H. Members have almost an unlimited scope of interesting, educational challenges including designing, constructing, and finishing wood. However, in order for them to complete the activities in the wood science units, they need your help.

In Unit II, your children will be introduced to power tools. For safety purposes, it is recommended that power tools not be used by children younger than 10 years old, and then only with the supervision of a leader or parent. Leaders can supervise

your children only while at meetings, so it is up to you to help at home. Make this a safe and enjoyable experience for your children. Help them get the most out of this project by:

- Making this a family project.
- Helping to plan and select woodworking projects that suit your children's ages and abilities.
- Working with them to decide what tools, equipment, and supplies will be needed.
- Helping them set goals they can realistically meet so that they don't get frustrated with the project.
- Planning time that you can work with your children on wood-working projects and activities.

For safety purposes, remember to supervise whenever they are using power tools. Be there to lend a hand, if needed, and to show them that you are interested in the work they are doing, but **DON'T DO THE WORK FOR THEM.**

It's a challenging world, **THE WONDERFUL WORLD OF WOOD!**

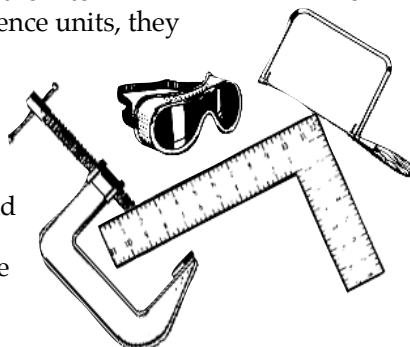



Introduction

Welcome to Unit II of Wood Science, THE WONDERFUL WORLD OF WOOD!

This is the second in the series of 4-H Wood Science manuals. If you have completed Wood Science I, you probably are asking, "Now what?" Wood Science can be so interesting and challenging that you never really finish. Making beautiful and useful things of wood is limited only by your interest and imagination.

Unit II and subsequent units will help you continue to grow in your ability to create and assemble items of wood. You will learn more about wood itself—how to identify wood, how to measure wood, and how to buy wood.

In the back of this manual are plans for some woodworking items you may wish to make; however, you also are encouraged to make items from other plans. Before you start, make sure you can get the necessary materials and make certain that you have, and can use, the right tools. Ask your parent or leader to help you select a woodworking project that is suited to your ability.

You may do your project work at home, or you may be invited to your leader's home or shop. You will enjoy the project more if you have your own work area in the shop, basement, or garage. Be sure to have a place to store your woodworking tools. The tools described in Wood Science Unit I make a good start on a tool set, and you may also want to add some of the tools that are discussed in this unit.

You will be using some power tools now: an electric drill, sander, saber saw, maybe a jigsaw, and others. These tools are powered by electricity to provide more force so you can do your woodworking jobs more easily and more accurately.

Considering your age and beginning skills, use power tools only when being supervised by a leader or parent. Be sure to read and obey the safety warnings provided by Woody Wise.

In Unit II, learn how to construct fun woodworking projects using different tools.



Measure and Mark

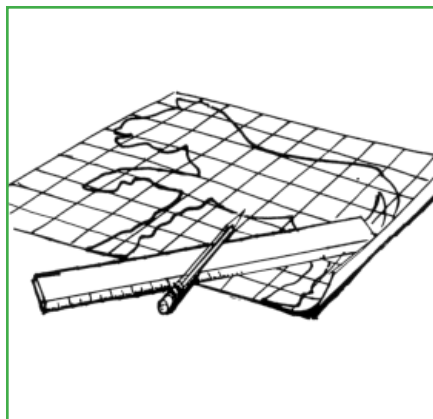

Use a Grid

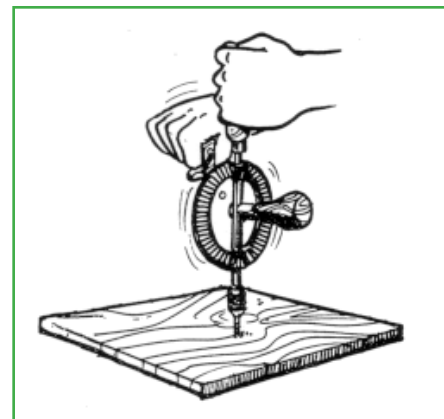

Drill Holes



Opportunities for Learning and Doing

In Wood Science, there are many different things you can do and things you can make. There also are many opportunities to learn while doing.

A list follows. These are merely suggestions. There may be other things you wish to add. Also, there may be things on the list you may not want to include.

1. Make a wooden toy or gift as a holiday gift or birthday present.
2. Learn to enlarge irregular-shaped drawings using the grid system.

Power Tool Users

Since moisture conducts electricity, never use an electric tool in wet or moist conditions.

Power tools put out quite a lot of force, but they can't think! They depend on you to think. So, stay alert all the time you are using them.

Wear safety goggles when driving nails and when using power tools. They protect the eyes from sawdust and chips.

3. Add to your tool set.
4. Build a tool box or storage area for your tools.
5. Start a collection of various-size wood screws.
6. Give a demonstration on the correct use of a hand drill, electric drill, or any other woodworking tool. Consider other possible demonstrations that are related to woodworking.
7. Learn the differences between hard and soft woods.
8. Make a list of different jobs that are related to the wood industry.
9. Talk to some of the people who work in those jobs. Find out what they do.
10. Make a list of products obtained from wood. Write a speech or give a club demonstration on products obtained from wood.

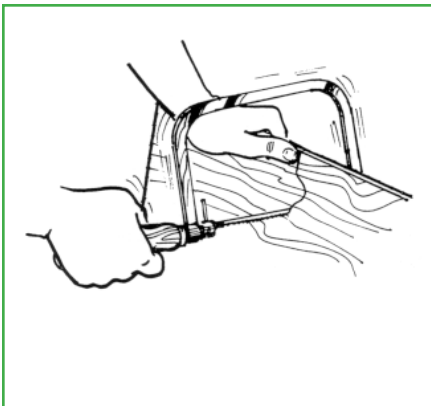

Sand Wood



Build Things

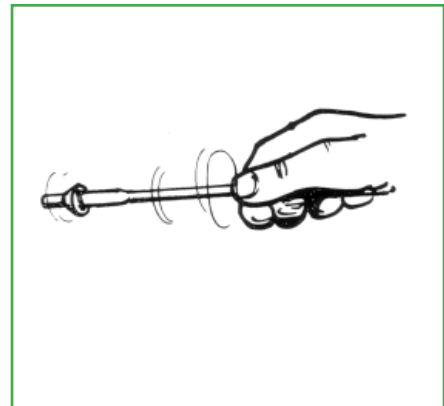

Use glue and finishes



Work Safely

1. When working in the shop area, wear comfortable clothes. Avoid loose-fitting or dangling clothing, which might get caught in a machine.
2. Avoid carrying sharp or pointed tools in your pocket. They may cut or scratch you or somebody else, or tear a chair or auto cushion.
3. Be sure every electric tool you use, such as a jig saw, electric drill, or sander, is double insulated or properly grounded to protect you from electrical shock.

Many manufacturers are now making portable electric tools with a specially insulated motor and switch housing. Since the housing provides a second layer of insulation to protect the operator, it is referred to as “double insulated” and does not require a third wire or prong to ground the tool. These units have a two-wire cord and should be identified as “DOUBLE INSULATED” and bear the (UL) label on the unit rather than just on the cord.

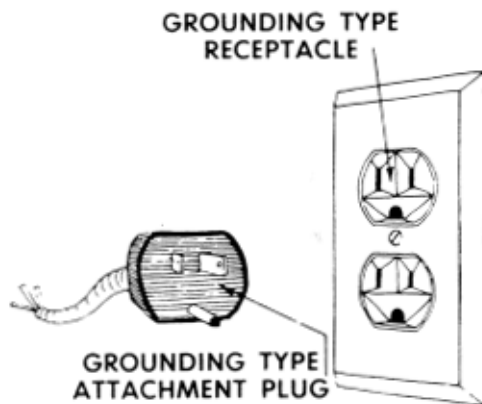

4. All tools that are not marked as double insulated should be properly grounded for protection against electrical shock. This can be done by connecting the tool to the power source with a cable or extension cord that has three conductors. The wire that attaches to the third blade of the plug safely grounds the tool. **This wire usually is green.**

Caution: A three-prong plug must always be plugged into a three-hole receptacle.

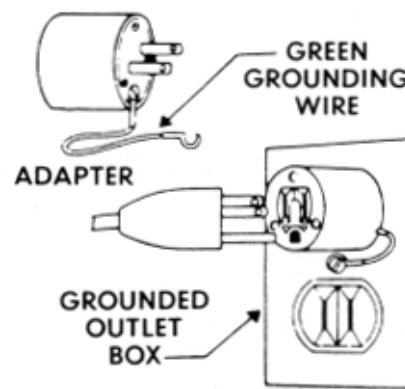

A grounding adapter used with a grounded outlet box.

Adapters are available for use with two-prong electrical outlets, but they should be used with caution. **Use an adapter only if the outlet box is grounded and the green grounding wire is properly attached.** (See illustration above.) If the above precautions are followed, you can then plug the three prongs of your tool into the adapter and use the tool safely.

Be sure to read your instruction manual before using your power tools. If your manual has been lost, ask your leader or parent for help *before* using the tool.